



SmarterGlass

state-of-the-art display solutions

www.smarterglass.com
978 997 4104
sales@smarterglass.com

Product Information

ISSUE DATA : 2006-07-25
MODEL : LTE430WQ-F07

**Note : The Product and specifications are subject to change without any notice.
Please ask for the latest Product Standards to guarantee the satisfaction of
your product requirements.**

PREPARED BY : Mobile Display Development Team

LCD DIVISION

Samsung Electronics Co., Ltd.



Revision History

Date	Rev. No.	Page	Summary
May.16.2006	000		Rev.000 was first issues.
May.25.2006	001	16	Back-Light was inserted.
June.11.2006	002	4	Inversion mode was corrected.
		8	Viewing angle was corrected.
JULY.24.2006	001	8	Note was corrected.
	002	8	Color chromaticity was inserted.
	003	9	Back-Light On condition was corrected.

Contents

General Description	-----	(4)
1. Absolute Maximum Ratings	-----	(6)
1.1 Absolute Ratings Of Environment		
1.2 Electrical Absolute Ratings		
2. Optical Characteristics	-----	(8)
3. Electrical Characteristics	-----	(12)
3.1 TFT-LCD Module		
3.2 Back-light Unit		
4.. Block Diagram	-----	(14)
4.1 TFT-LCD Module(Interface System Structure) with Back Light Unit		
4.2 Back-light Unit		
5. Input Terminal Pin Assignment	-----	(15)
5.1 Input Signal & Power		
5.2 Back-Light Unit		
5.3 Input Signal, Basic Display colors and Gray Scale of Each Colors		
5.4 Pixel Format		
6. Interface Timing	-----	(18)
7. Power On/Off Sequence	-----	(23)
8. Outline Dimension	-----	(24)
9. Packing	-----	(25)
10. Marking & Others	-----	(26)
11. General Precaution	-----	(27)
11.1 Handling		
11.2 Storage		
11.3 Operation		
11.4 Others		

General Description

* Description

LTE430WQ-F07 is a TMR(Transmissive with Micro Reflective) type color active matrix TFT (Thin Film Transistor) liquid crystal display (LCD) that uses amorphous silicon TFT as a switching devices. This model is composed of a TFT-LCD module, a driver circuit and a back-light unit.

The resolution of a 4.3" contains 480x272(RGB) dots and can display up to 16.7M colors.

* Features

- triple-gate & Dual ASG
- Transmissive with Micro Reflective type and back-light with seven LEDs are available.
- TN(Twisted Nematic) mode.
- Column inversion mode.
- 24bit RGB Interface
- DE(Data Enable) & SYNC mode - DE, Vsync, Hsync, DOTCLK

* Applications

- Display terminals for PMP(Portable Multimedia Player) , Portable CNS(P-CNS) , MP3 application products.
- Display terminals for AV application products.

*** General information**

Items	Specification	Unit	Note
Display area	95.04(H) x 53.856(V) (4.3" diagonal)	mm	-
Driver element	a-Si TFT active matrix	-	-
Display colors	16,777,212	colors	-
Number of dots	480(H) x 272 x RGB(V)	dot	-
Pixel arrangement	RGB stripe	-	-
Pixel pitch	0.198(H) x 0.198(V)	mm	128dpi
Display mode	Normally White	-	-
Viewing direction	6	o'clock	-

*** Mechanical information**

Item		Min.	Typ.	Max.	Unit	Note
Module size	Horizontal(H)	105.3	105.5	105.7	mm	-
	Vertical(V)	67.0	67.2	67.4	mm	(1)
	Depth(D)	3.75	3.95	4.15	mm	(1)
Weight		-	60.5	64	g	(2)

Note (1) Not include FPC.

Refer to the Outline Dimension in the "8. Outline Dimension" for further information.

(2) Module and Back-light unit are included.

1. Absolute Maximum Ratings

1.1 Absolute Ratings Of Environment

ITEM	MIN	MAX	REMARK
Storage Temperature	-30	70	Note(1)
Operating Temperature	-20	60	Note(2)(3)

Note(1) 90%RH maximum humidity, 60 maximum wet-bulb temperature

- (2) When operated at a temperature lower than 0 , the LCD worked slowly and the screen appeared low-contrast images due to the characteristics of LC(Liquid Crystal).
- (3) If any fixed pattern is displayed on LCD for minutes, image-sticking phenomenon may occur.

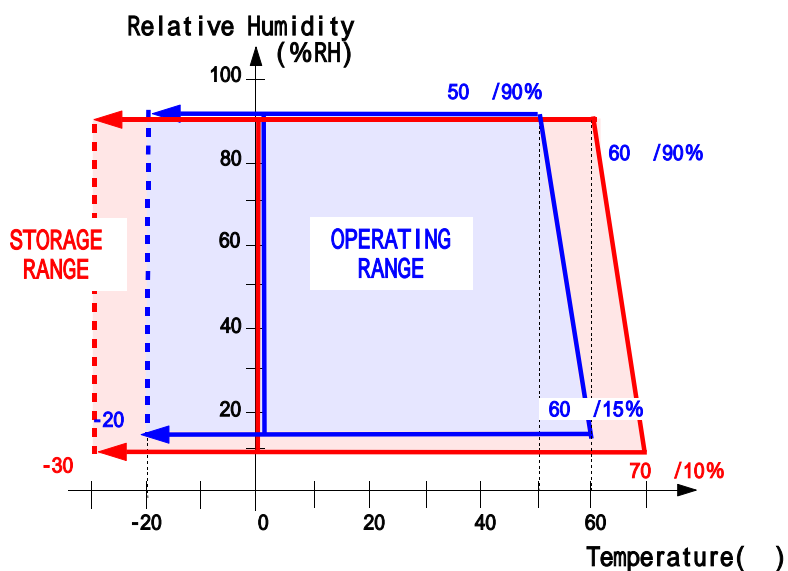

Temperature & Humidity Graph at Absolute Environment

1.2 Electrical Absolute Ratings

(1) TFT-LCD Module

(Ta = 25 ± 2°C, VSS=GND=0)

Item	Symbol	Min.	Max.	Unit	Note
Input voltage	VDD	-0.3	4.6	V	-

(2) Back-Light Unit

(Ta = 25 ± 2°C)

Item	Symbol	Min.	Max.	Unit.	Note
Current	I _B	-	25	mA	(1)

Note (1) Permanent damage to the device may occur if maximum values are exceeded or reverse voltage is loaded.

Functional operation should be restricted to the conditions described under normal operating conditions.

2. Optical Characteristics

The following items are measured under stable conditions. The optical characteristics should be measured in a dark room or equivalent state with the methods shown in Note (1).

Measuring equipment: LCD-5000, SR3, BM-7, EZ-Contrast

(Ta=25 ± 2°C , VDD=3.3V, fv=60Hz , fDCLK=9.2MHz , IL=20mA)

Item	Symbol	Condition	Min.	Typ.	Max.	Unit	Note	
Contrast ratio (Center point)	C/R		200	400	-	-	(2) SR3	
Luminance of white (Center point)	YL	NOTE (1)	280	350	-	cd/m ²	(3) SR3	
Response time	Rising	T _R	-	5	15	msec	(4) BM-7	
	Falling	T _F	-	25	30			
Color chromaticity (CIE 1931)	White	W _X	Normal Viewing Angle B/L On	0.272	0.322	0.372	-	(5) SR3
		W _Y		0.289	0.339	0.389		
	Red	R _X		0.554	0.604	0.654		
		R _Y		0.317	0.367	0.417		
	Green	G _X		0.314	0.364	0.414		
		G _Y		0.508	0.558	0.608		
	Blue	B _X		0.100	0.150	0.200		
		B _Y		0.066	0.116	0.166		
Viewing angle	Hor.	L	C/R 10 B/L On	75	80	-	Degrees	(6) Ez-Contrast
		R		75	80	-		
	Ver.	H		55	60	-		
		L		55	60	-		

Note (1) Test Equipment Setup

After stabilizing and leaving the panel alone at a given temperature for 30 min , the measurement should be executed. Measurement should be executed in a stable, windless, and dark room. 30 min after lighting the back-light. This should be measured in the center of screen.

Environment condition : $T_a = 25 \pm 2 \text{ }^\circ\text{C}$

Back-Light On condition

Photodetector	Field
SR3	1°
BM-7	1°

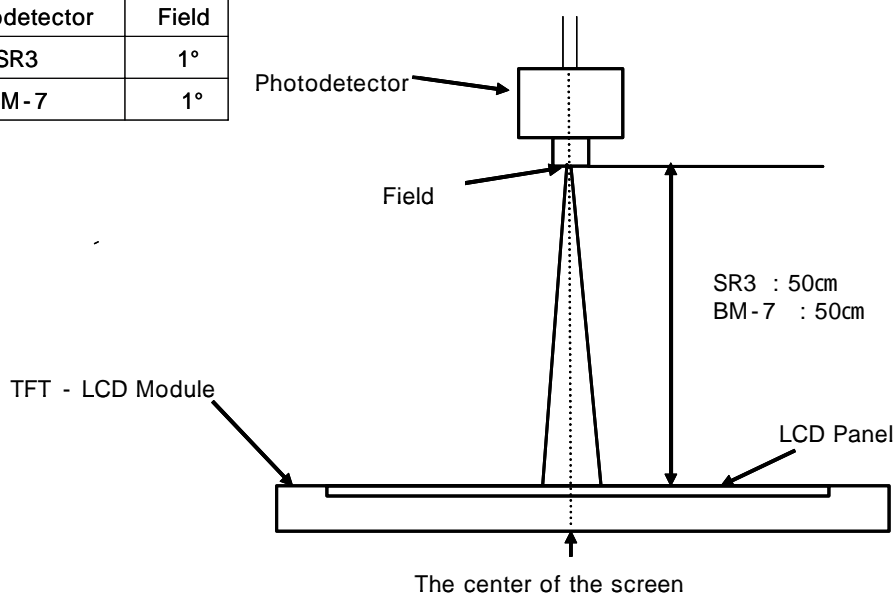

Back-Light Off condition

Photodetector	Field
LCD-5000	1°

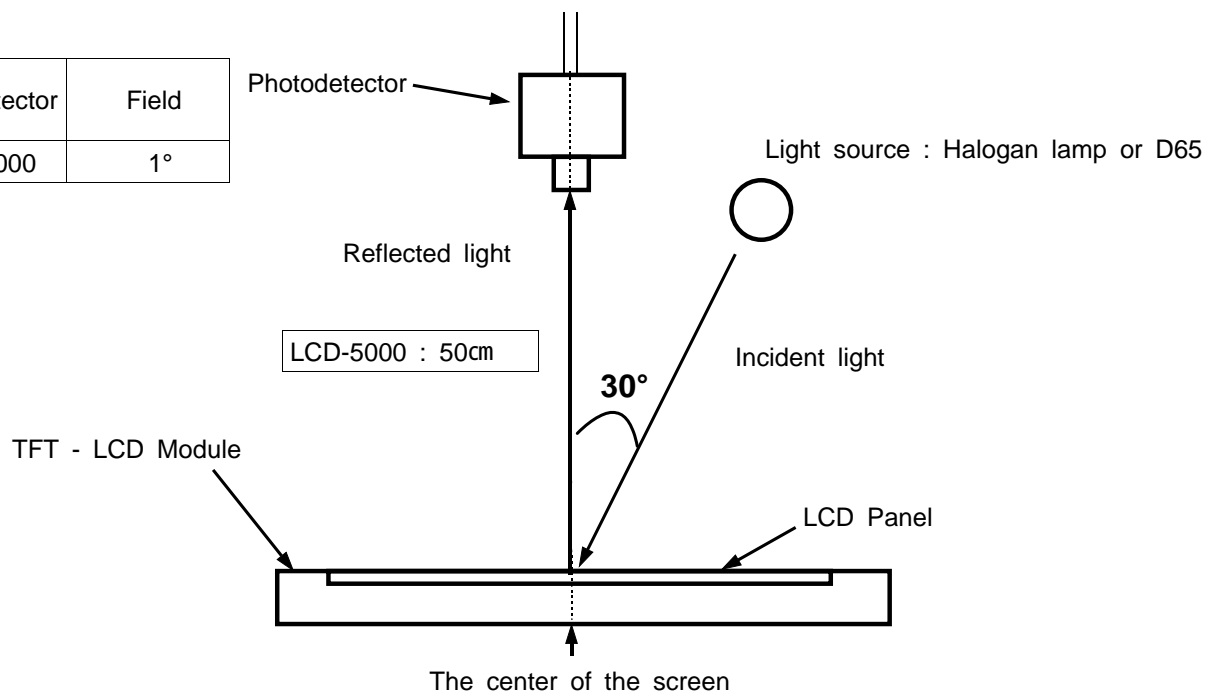

Optical Measuring Equipment Setup

Note (2) Definition of Contrast Ratio (C/R) : Ratio of gray max (Gmax) & gray min (Gmin) at the center point

$$CR = \frac{G_{max}}{G_{min}}$$

* Gmax : Luminance with all pixels white
* Gmin : Luminance with all pixels black

Note (3) Definition of Luminance of White : Luminance of white at the center point (@)

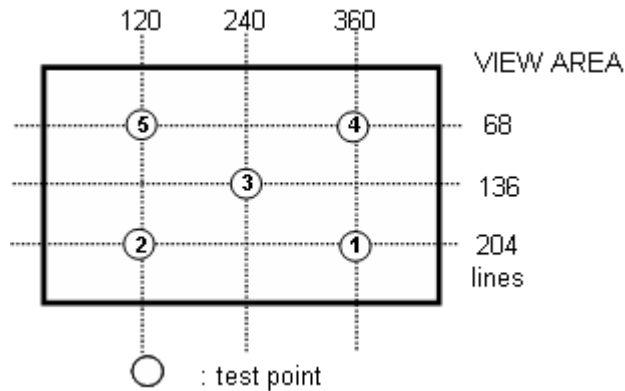

Note (4) Definition of Response time : Sum of T_r , T_f

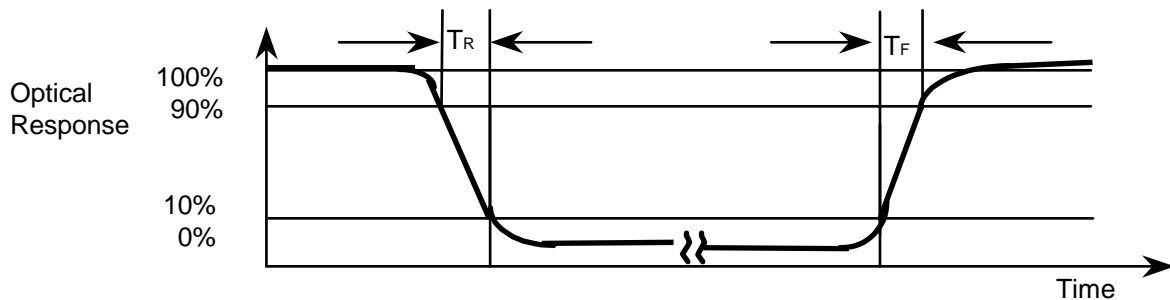
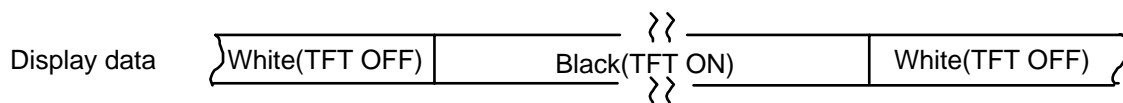

Note (5) Definition of Color Chromaticity (CIE 1931)

Color coordinate of white & red, green, blue at center point.

Note (6) Definition of Viewing Angle : Viewing angle range (CR 10)

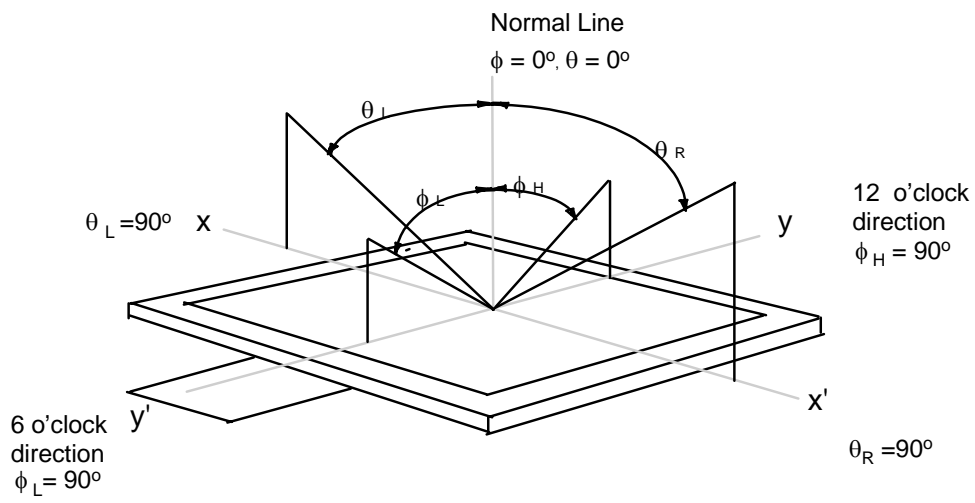

3. Electrical Characteristics

3.1 TFT-LCD Module

$T_a = 25 \pm 2^\circ\text{C}$

ITEM	Symbol	Min.	Typ.	Max.	Unit	Note
Logic supply voltage	VDD	2.9	3.3	3.5	V	
Vsync Frequency	f_v	-	60	70	Hz	
Hsync Frequency	f_H	-	17.26	-	kHz	
Main Frequency	f_{DCLK}	-	9.2	15.0	MHZ	
Power Dissipation	White	-	80	95	mW	(1),(2)
	Black	-	85	100	mW	

Note (1). $f_v=60\text{Hz}$, $f_{DCLK}=9.2\text{MHZ}$, $VDD=3.3\text{V}$

Note (2). Power Dissipation check pattern

a) White Pattern

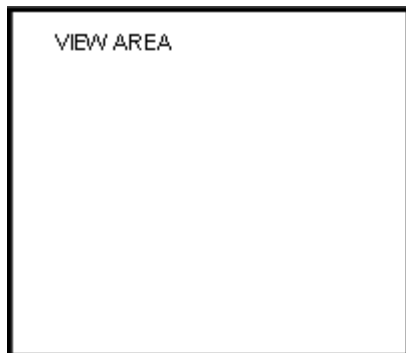

b) Black Pattern

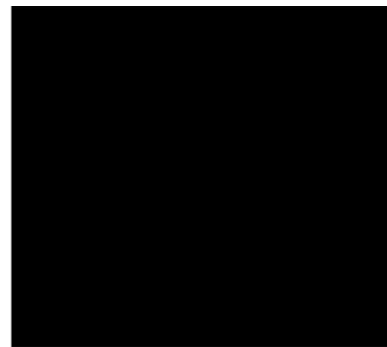

3.2 Back-Light unit

The back-light system is an edge-lighting type with seven white LED(Light Emitting Diode)s.

(Ta=25 ± 2°C)

Item	Symbol	Min.	Typ.	Max.	Unit	Note
LEDs Current	I _B	-	20	TBD	mA	(1)
Power Consumption	P _{BL}	-	480	TBD	mW	(2)

Note (1) Seven LEDs serial type.

(2) Where I_B = 20 mA, V_B = P_{BL} / I_B

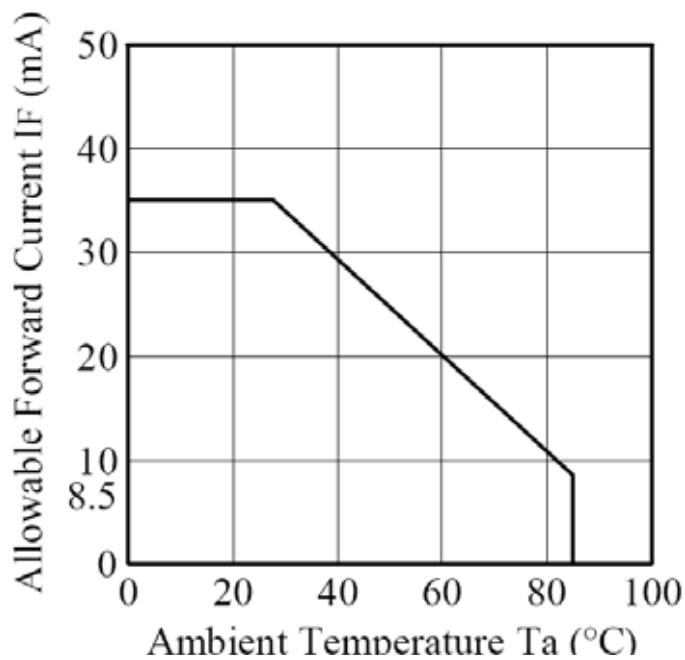

4. Block Diagram

4.1 TFT-LCD Module (Interface System Structure) with Back Light Unit

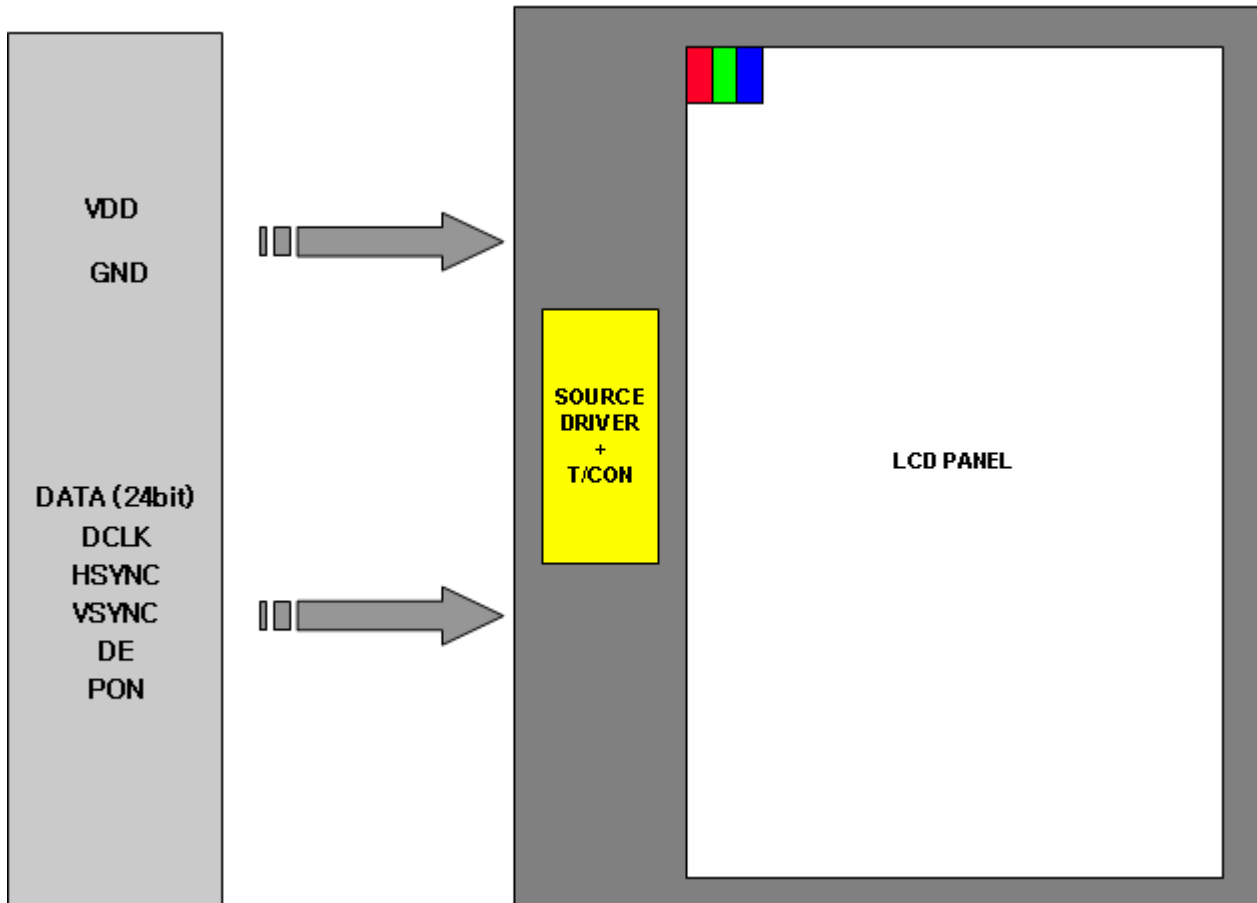

4.2 Back-light Unit

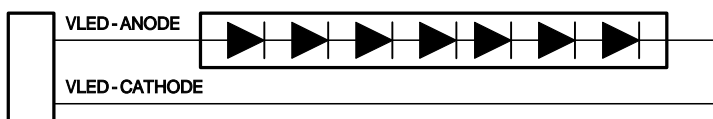

5. Input Terminal Pin Assignment

5.1 Input Signal & Power (Connector type : 40Pin)

Pin No.	Symbol	Description	Remark	Pin No.	Symbol	Description	Remark
1	VSS	Ground		21	B0	Blue data (LSB)	
2	VSS	Ground		22	B1	Blue data	
3	VDD	Power Supply	3.3V	23	B2	Blue data	
4	VDD	Power Supply	3.3V	24	B3	Blue data	
5	R0	Red data (LSB)		25	B4	Blue data	
6	R1	Red data		26	B5	Blue data	
7	R2	Red data		27	B6	Blue data	
8	R3	Red data		28	B7	Blue data (MSB)	
9	R4	Red data		29	VSS	Ground	
10	R5	Red data		30	PCLK	dot clock	
11	R6	Red data		31	PON	Display on/off	
12	R7	Red data (MSB)		32	HSYNC	Horizontal Sync	
13	G0	Green data (LSB)		33	YSYNC	Vertical Sync	
14	G1	Green data		34	DE	Data Enable	
15	G2	Green data		35	N/C	No Connect	
16	G3	Green data		36	N/C	No Connect	
17	G4	Green data		37	N/C	No Connect	
18	G5	Green data		38	N/C	No Connect	
19	G6	Green data		39	VSS	Ground	
20	G7	Green data (MSB)		40	VSS	Ground	

5.2 Back-Light(Connector: 4 Pin FPC)

Pin No.	Symbol	Function
1	VLED-	Ground(Cathode)
2	NC	No Connector
3	NC	No Connector
4	VLED+	LED Input Terminal(Anode)

5.3 Input Signal, Basic Display Colors and Gray Scale of Each Colors

COLOR	DISPLAY	DATA SIGNAL																								GRAY SCALE LEVEL
		RED							GREEN							BLUE										
		R0	R1	R2	R3	R4	R5	R6	R7	G0	G1	G2	G3	G4	G5	G6	G7	B0	B1	B2	B3	B4	B5	B6	B7	
BASIC COLOR	BLACK	0	0	0	0	0	0	0	0	0	0	0	0	0	0	0	0	0	0	0	0	0	0	0	0	-
	BLUE	0	0	0	0	0	0	0	0	0	0	0	0	0	0	0	0	1	1	1	1	1	1	1	1	-
	GREEN	0	0	0	0	0	0	0	0	1	1	1	1	1	1	1	1	0	0	0	0	0	0	0	0	-
	CYAN	0	0	0	0	0	0	0	0	1	1	1	1	1	1	1	1	1	1	1	1	1	1	1	1	-
	RED	1	1	1	1	1	1	1	1	0	0	0	0	0	0	0	0	0	0	0	0	0	0	0	0	-
	MAGENTA	1	1	1	1	1	1	1	1	0	0	0	0	0	0	0	0	1	1	1	1	1	1	1	1	-
	YELLOW	1	1	1	1	1	1	1	1	1	1	1	1	1	1	1	1	0	0	0	0	0	0	0	0	-
	WHITE	1	1	1	1	1	1	1	1	1	1	1	1	1	1	1	1	1	1	1	1	1	1	1	1	-
GRAY SCALE OF RED	BLACK	0	0	0	0	0	0	0	0	0	0	0	0	0	0	0	0	0	0	0	0	0	0	0	R0	
	DARK	1	0	0	0	0	0	0	0	0	0	0	0	0	0	0	0	0	0	0	0	0	0	0	R1	
		0	1	0	0	0	0	0	0	0	0	0	0	0	0	0	0	0	0	0	0	0	0	0	R2	
		:	:	:	:	:	:	:	:	:	:	:	:	:	:	:	:	:	:	:	:	:	:	:	R3~R252	
		:	:	:	:	:	:	:	:	:	:	:	:	:	:	:	:	:	:	:	:	:	:	:		:
	LIGHT	1	0	1	1	1	1	1	1	0	0	0	0	0	0	0	0	0	0	0	0	0	0	0	R253	
		0	1	1	1	1	1	1	1	0	0	0	0	0	0	0	0	0	0	0	0	0	0	0	R254	
	RED	1	1	1	1	1	1	1	1	0	0	0	0	0	0	0	0	0	0	0	0	0	0	0	R255	
GRAY SCALE OF GREEN	BLACK	0	0	0	0	0	0	0	0	0	0	0	0	0	0	0	0	0	0	0	0	0	0	0	G0	
	DARK	0	0	0	0	0	0	0	0	1	0	0	0	0	0	0	0	0	0	0	0	0	0	0	G1	
		0	0	0	0	0	0	0	0	0	1	0	0	0	0	0	0	0	0	0	0	0	0	0	G2	
		:	:	:	:	:	:	:	:	:	:	:	:	:	:	:	:	:	:	:	:	:	:	:	G3~G252	
		:	:	:	:	:	:	:	:	:	:	:	:	:	:	:	:	:	:	:	:	:	:	:		:
	LIGHT	0	0	0	0	0	0	0	0	1	0	1	1	1	1	1	1	0	0	0	0	0	0	0	G253	
		0	0	0	0	0	0	0	0	0	1	1	1	1	1	1	1	0	0	0	0	0	0	0	G254	
	GREEN	0	0	0	0	0	0	0	0	1	1	1	1	1	1	1	1	0	0	0	0	0	0	0	G255	
GRAY SCALE OF BLUE	BLACK	0	0	0	0	0	0	0	0	0	0	0	0	0	0	0	0	0	0	0	0	0	0	0	B0	
	DARK	0	0	0	0	0	0	0	0	0	0	0	0	0	0	0	0	1	0	0	0	0	0	0	B1	
		0	0	0	0	0	0	0	0	0	0	0	0	0	0	0	0	1	0	0	0	0	0	0	B2	
		:	:	:	:	:	:	:	:	:	:	:	:	:	:	:	:	:	:	:	:	:	:	:	B3~B252	
		:	:	:	:	:	:	:	:	:	:	:	:	:	:	:	:	:	:	:	:	:	:	:		:
	LIGHT	0	0	0	0	0	0	0	0	0	0	0	0	0	0	0	0	1	0	1	1	1	1	1	B253	
		0	0	0	0	0	0	0	0	0	0	0	0	0	0	0	0	1	1	1	1	1	1	1	B254	
	BLUE	0	0	0	0	0	0	0	0	0	0	0	0	0	0	0	0	1	1	1	1	1	1	1	B255	

Note) Definition of Gray :

Rn : Red Gray, Gn : Green Gray, Bn : Blue Gray (n = Gray level)

Input Signal : 0 = Low level voltage, 1 = High level voltage

5.4 PIXEL FORMAT

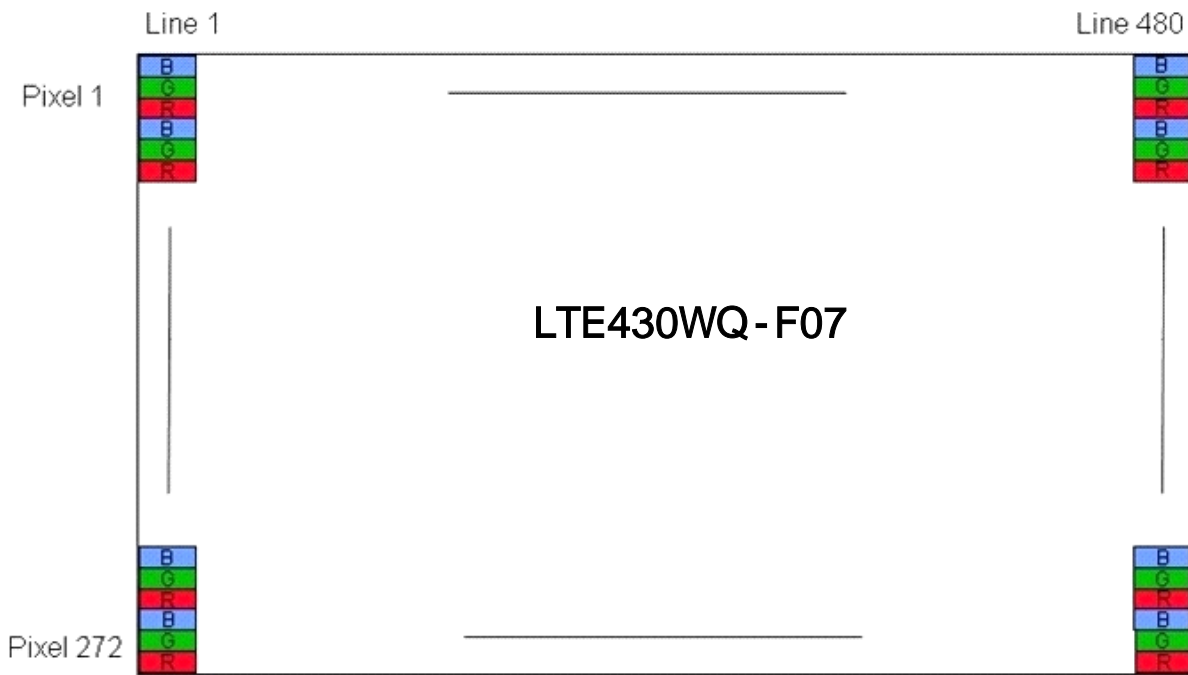

6. INTERFACE TIMING

6-1. Vertical timing

Signal	Symbol	Min.	Typ.	Max.	Unit	Note
Frame Frequency	fFRM	-	60	70	Hz	
VSYNC(Frame) Period	VCYC	239	288	335	H	
VSYNC Low width	VLW	1	10	-	H	
Vertical Display Period	VDP		272	-	H	
Vertical Back porch	VBP	-	12	-	H	
Vertical Front porch	VFP	2	4	-	H	

6-2. Horizontal timing

Signal	Symbol	Min.	Typ.	Max.	Unit	Note
HSYNC(1H) Period	HCYC	490	533	605	DOTCLK	
HSYNC Low width	HLW	4	41	-	DOTCLK	
Horizontal Display Period	HDP	-	480	-	DOTCLK	
Horizontal Back porch	HBP	8	45	-	DOTCLK	
Horizontal Front porch	HFP	2	8	-	DOTCLK	
DOTCLK Frequency	f _{DOTCLK}	-	9.2	15	MHz	@fFRM=60Hz

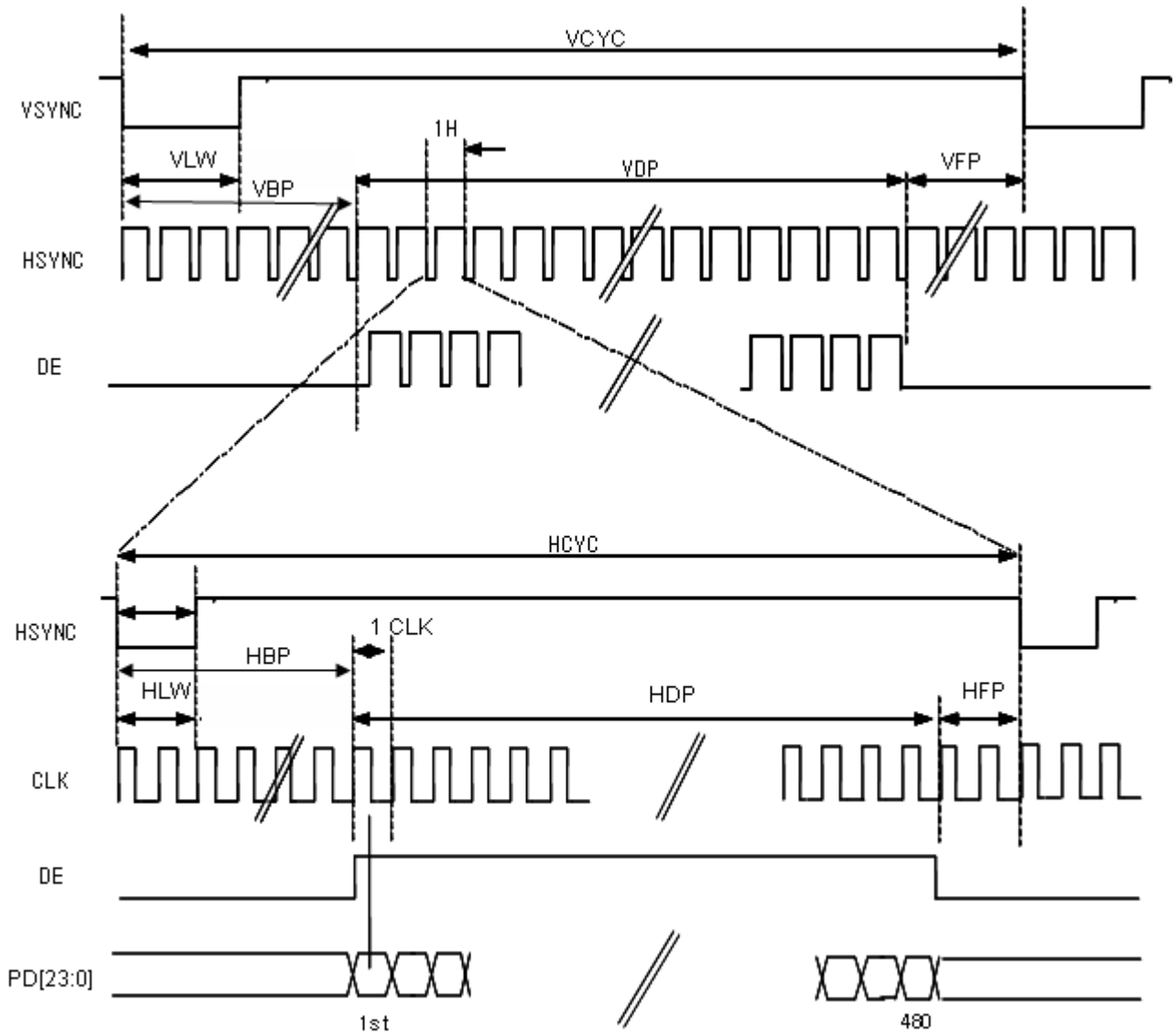

6-3. AC characteristics

Operating at VDD=2.25~2.9V , Ta = -40 ~+85

Parameter	Symbol	Min.	Typ.	Max.	Unit
VSYNC,HSYNC setup time	t_{SYNCS}	10	-	-	ns
ENABLE (DE) setup time	t_{ENS}	10	-	-	
ENABLE (DE) hold time	t_{ENH}	10	-	-	
DOTCLK "Low" level pulse width	P_{WDL}	25	-	-	
DOTCLK "High" level pulse width	P_{WDH}	25	-	-	
DOTCLK cycle time	t_{CYCD}	66.7	-	-	
Data setup time	t_{PDS}	10	-	-	
Data hold time	t_{PDH}	10	-	-	
DOTCLK,VSYNC,HSYNC clock rise/fall time	t_{rgr} t_{rgf}	-	-	5	

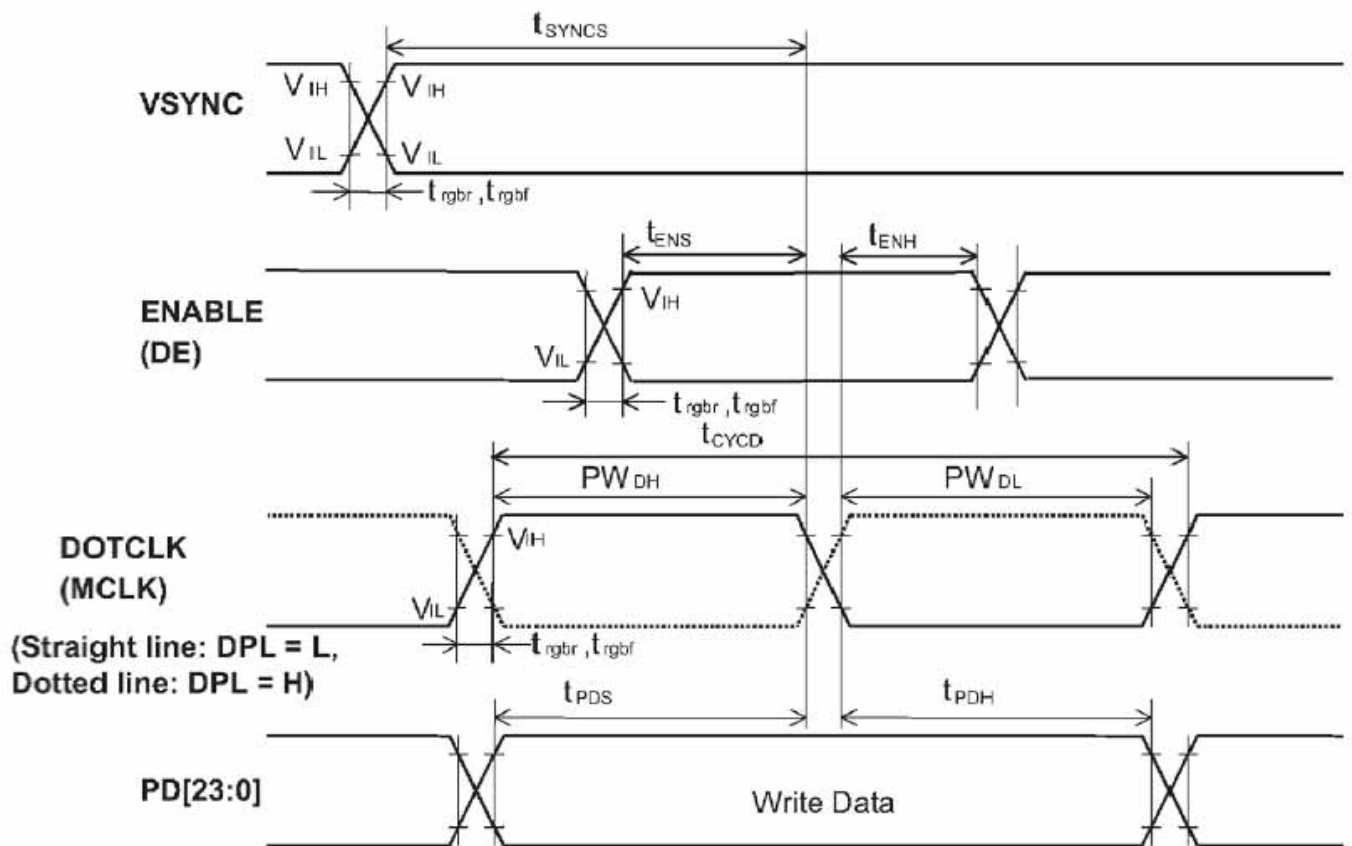

6-4. PON timing characteristics.

Operating at VDD=2.25~2.9V , Ta = -40 ~+85

Item	Symbol	Min.	Typ.	Max.	unit
PON setup (SYNC mode)	$t_{PONS\bar{V}}$	10	-	-	DOTCLK

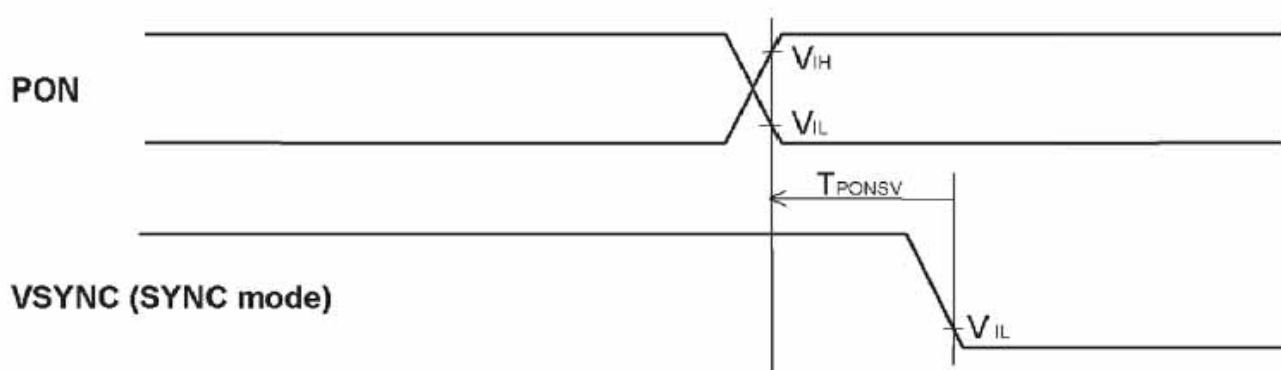

7. Power On/Off Sequence

- To prevent a latch-up or DC operation of the LCD module, the power on/off sequence should be as the diagram below.

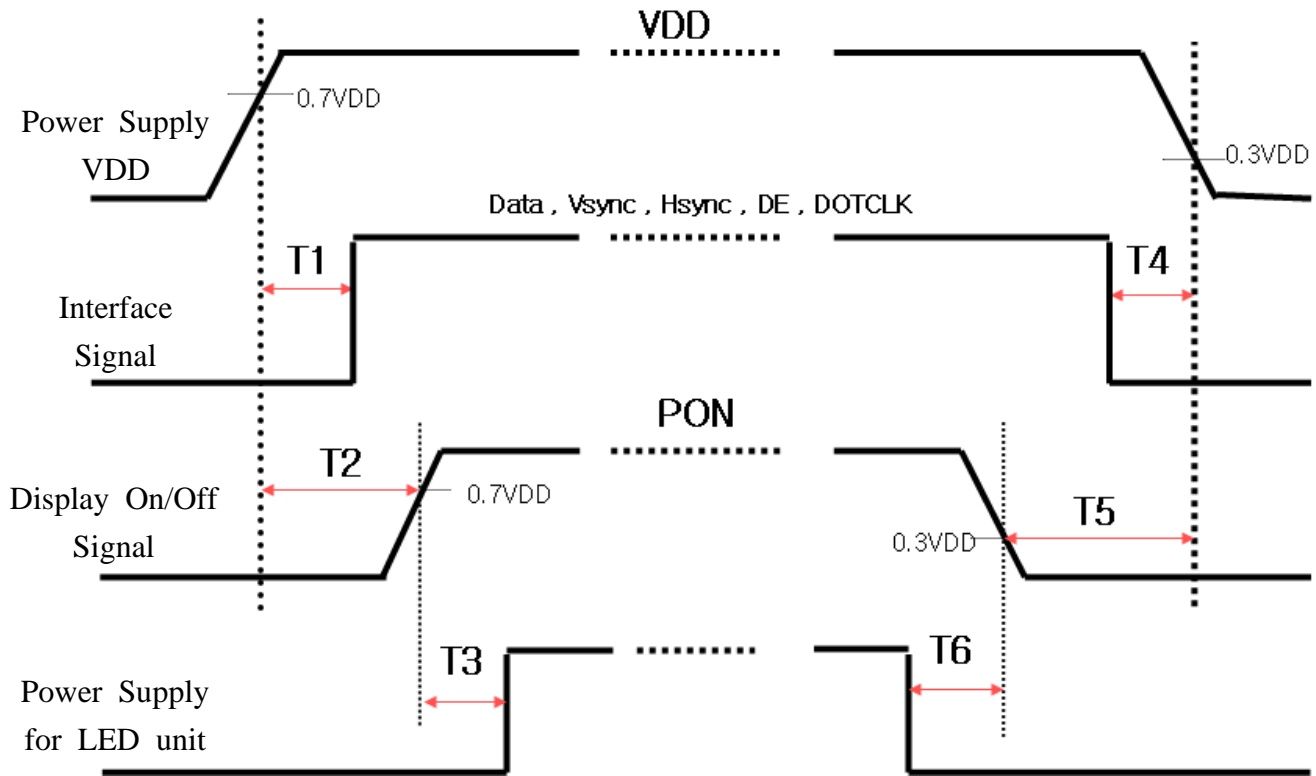

Symbol	Specification	Note
T1	$0 \text{ ms} < T1 < T2$	
T2	$5 \text{ ms} < T2$	(1)
T3	$10 \text{ frames} < T3$	
T4	$10 \text{ ms} < T4 < T5$	
T5	$(5 \text{ frames} + T4) < T5$	(1)
T6	$10 \text{ frames} < T6$	

Note(1) Refer to "6-4. PON timing characteristics."

Approval

8. Outline Dimension

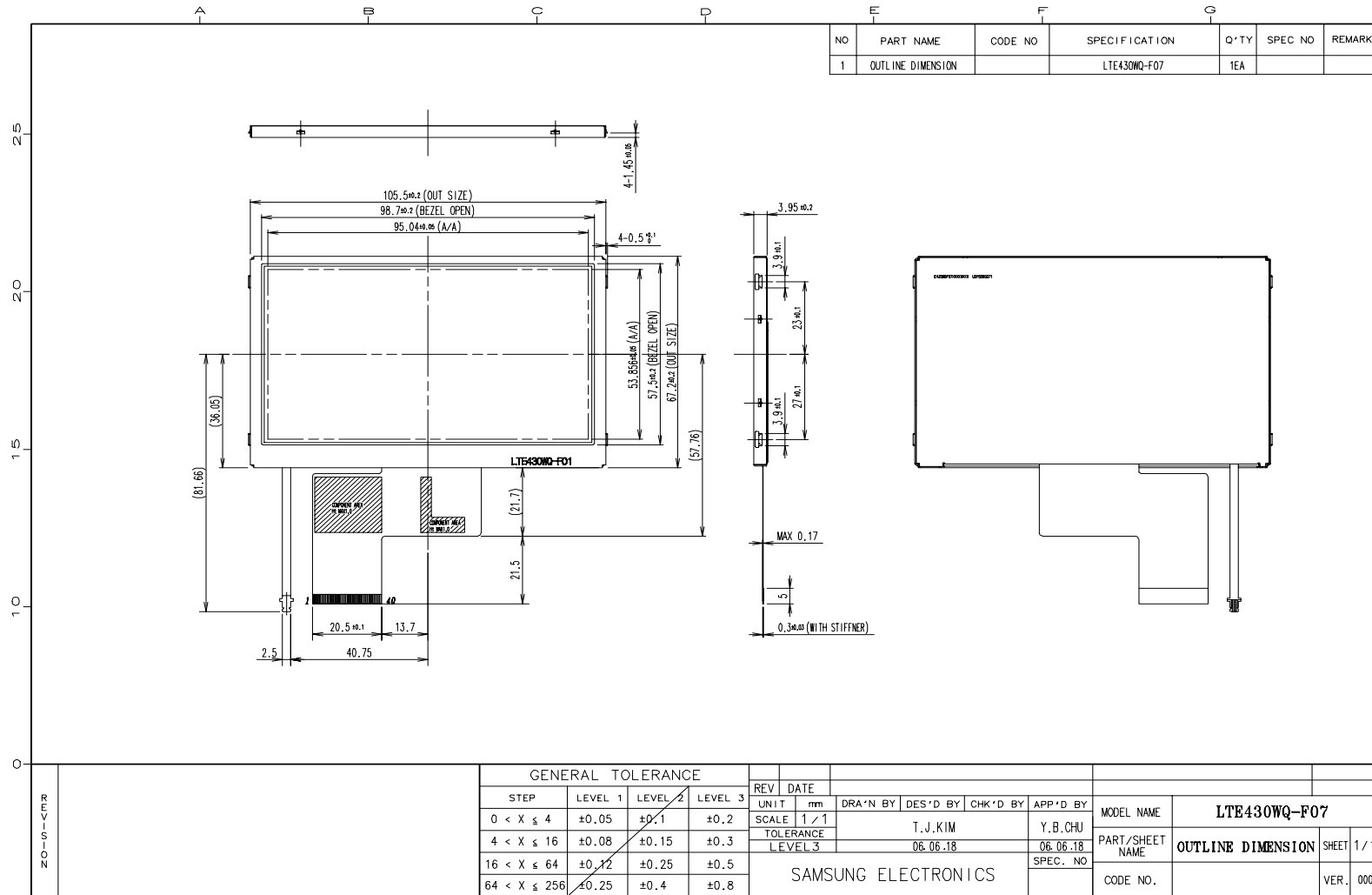

9. Packing

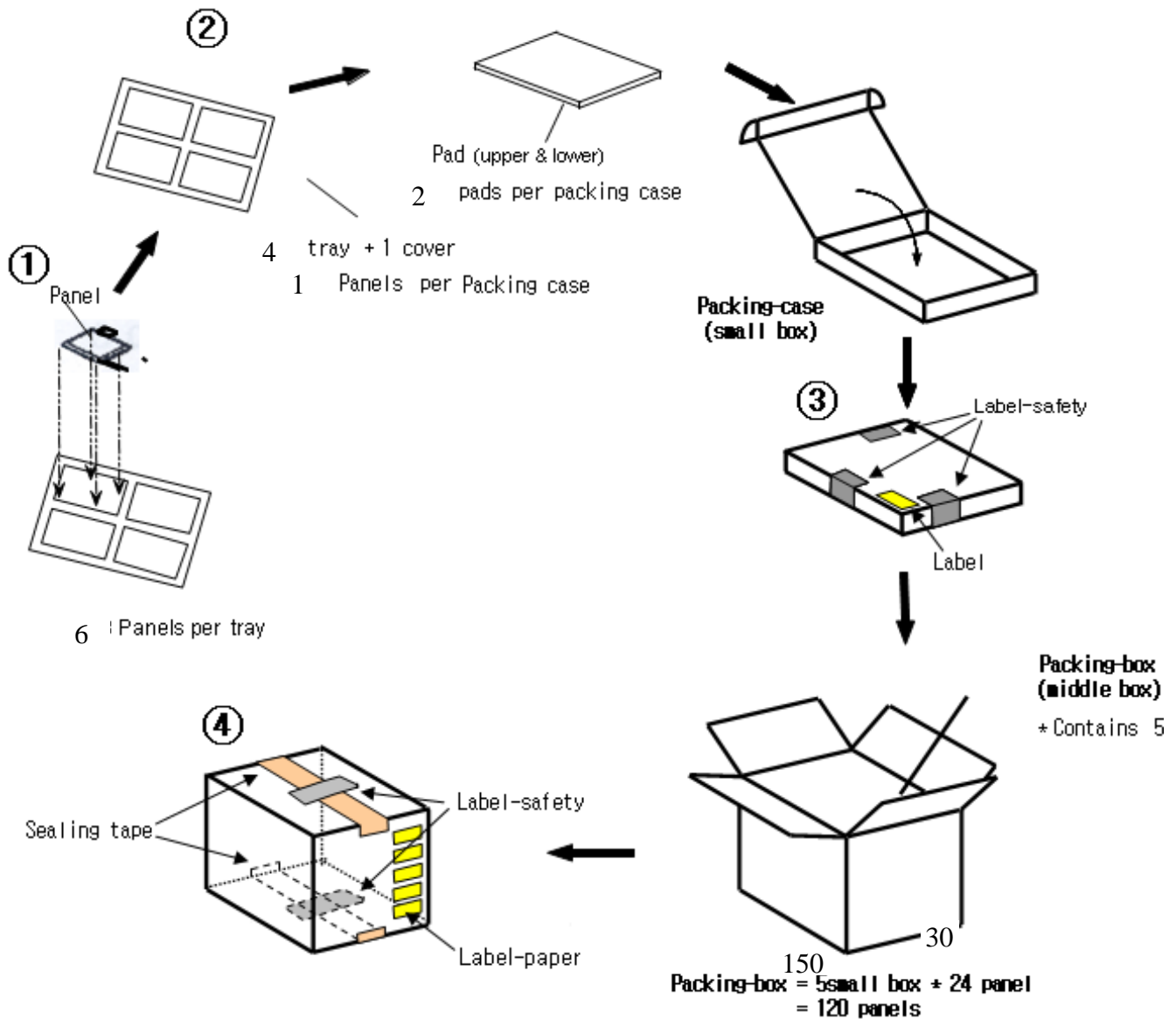

Note

- (1) Total : Case: Approx. : TBD Kg
Box: Approx. : TBD Kg
- (2) Size : Case: 490(W) x 342(D) x 58(H)
Box: 505(W) x 355(D) x 312(H)
- (3) Place the panels in the tray facing the direction shown in the figure.
- (4) Place 4 tray and cover(empty tray) and pads inside the packing-case.
- (5) Place 5 packing-case inside the packing-box. (Affix the label)
- (6) Seal the packing-box. Affix the label-safety.

10. Marking & Others

A nameplate bearing followed by is affixed to a shipped product at the Specified location on each product.

(1) Packing case attach

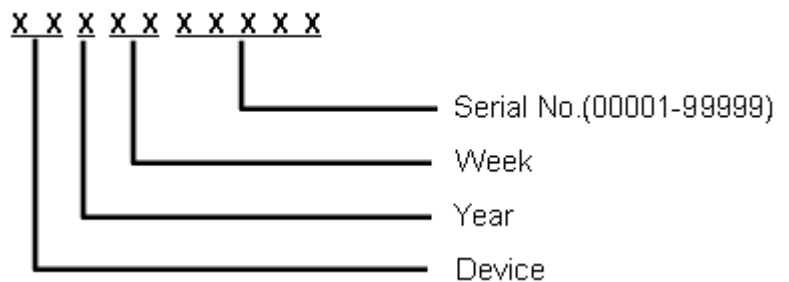
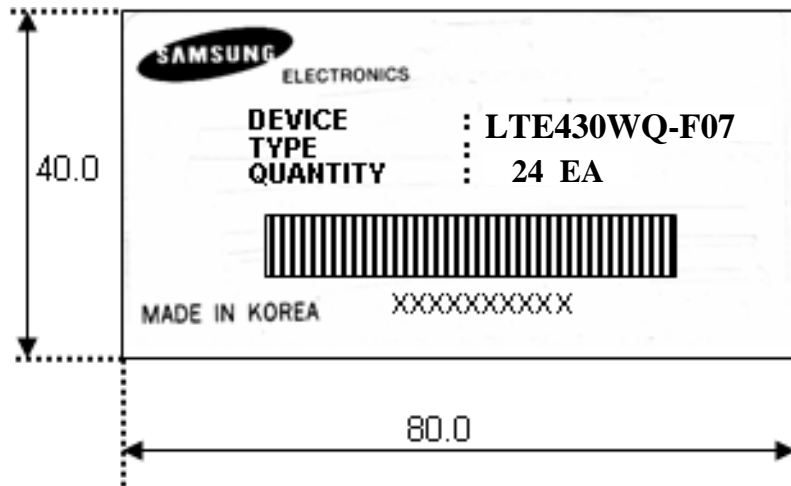

11. General Precautions

11.1 Handling

- (a) When the module is assembled, it should be attached to the system firmly. Be careful not to twist and bend the module.
- (b) Refrain from strong mechanical shock and / or any force to the module. In addition to damage, this may cause improper operation or damage to the module and back-light unit.
- (c) Note that polarizers are very fragile and could be easily damaged. Do not press or scratch the surface harder than a HB pencil lead.
- (d) Wipe off water droplets or oil immediately. If you leave the droplets for a long time, Staining and discoloration may occur.
- (e) If the surface of the polarizer is dirty, clean it using some absorbent cotton or soft cloth.
- (f) The desirable cleaners are water, IPA(Isopropyl Alcohol) or Hexane. Do not use Ketone type materials(ex. Acetone), Ethyl alcohol, Toluene, Ethyl acid or Methyl chloride. It might permanent damage to the polarizer due to chemical reaction.
- (g) If the liquid crystal material leaks from the panel, it should be kept away from the eyes or mouth. In case of contact with hands, legs or clothes, it must be washed away thoroughly with soap.
- (h) Protect the module from static , it may cause damage to the Integrated Gate Circuit.
- (i) Use finger-stalls with soft gloves in order to keep display clean during the incoming inspection and assembly process.
- (j) Do not disassemble the module.
- (k) Do not adjust the variable resistor which is located on the back side.
- (l) Protection film for polarizer on the module shall be slowly peeled off just before use so that the electrostatic charge can be minimized.
- (m) Pins of I/F connector shall not be touched directly with bare hands

11.2 Storage

- (a) Do not leave the panel in high temperature, and high humidity for a long time. It is highly recommended to store the module with temperature from 0 to 35°C and relative humidity of less than 70%.
- (b) Do not store the TFT-LCD module in direct sunlight.
- (c) The module shall be stored in a dark place. It is prohibited to apply sunlight or fluorescent light during the store.

11.3 Operation

- (a) Do not connect, disconnect the module in the "Power On" condition.
- (b) Power supply should always be turned on/off by the "Power on/off sequence"
- (c) Module has high frequency circuits. Sufficient suppression to the electromagnetic interference shall be done by system manufacturers. Grounding and shielding methods may be important to minimize the interference.

11.4 Others

- (a) The Liquid crystal is deteriorated by ultraviolet, do not leave it in direct sunlight and strong ultraviolet ray for many hours.
- (b) Avoid condensation of water. It may result in improper operation or disconnection of electrode.
- (c) Do not exceed the absolute maximum rating value. (the supply voltage variation, input voltage variation, variation in part contents and environmental temperature, and so on) Otherwise the panel may be damaged.
- (d) If the panel displays the same pattern continuously for a long period of time, it can be the situation when the image "Sticks" to the screen.
- (e) This panel has its circuitry FPC on the bottom side and should be handled carefully in order not to be stressed.
- (f) Avoid shortness between LED soldering pad.