



SmarterGlass

state-of-the-art display solutions

www.smarterglass.com
978 997 4104
sales@smarterglass.com



ISSUED DATE : 2006-05-13

SAMSUNG TFT-LCD PRODUCT INFORMATION
MODEL : LTM300M1 - P01

Note : This is Product Information is subject to change after 3 months of issuing date.

LCD Application Engineering 2, TCS Team

Samsung Electronics Co . , LTD.



MODEL	003 _ LTM300M1- P01	Page	1/35
-------	---------------------	------	------

Contents

General Description ----- (3)

1. Absolute Maximum Ratings ----- (4)

2. Optical Characteristics ----- (6)

3. Electrical Characteristics ----- (12)

 3.1 TFT LCD Module

 3.2 Back Light Unit

 3.3 Inverter Specification

4. Block Diagram ----- (17)

 4.1 TFT LCD Module

 4.2 Back Light Unit

5. Input Terminal Pin Assignment ----- (18)

 5.1.1 Input Signal

 5.1.2 Input Power

 5.1.3 Inverter Input Connector

 5.2 Back light unit

 5.3 Input Signals, Basic Display Colors and Gray Scale of Each Color

6. Interface Timing ----- (23)

 6.1 Timing Parameters – Dual mode

 6.2 Timing Parameters – Single mode

 6.3 Timing diagrams of interface signal (DE only mode)

 6.4 TMDS Interface Timing Setting

 6.5 TMDS Rx(Sil1169) Programming Mode Data

 6.6 TMDS Rx(Sil1169) Input Skew

 6.7 TMDS Rx(Sil1169) I2C Data Valid Delay

 6.8 Power ON/OFF Sequence

 6.9 Inverter Power Sequence

 6.10 VDD Power Dip Condition

7. Outline Dimension ----- (31)

8. General Precaution ----- (33)

 8.1 Handling

 8.2 Storage

 8.3 Operation

 8.4 Others

General Description

Description

LTM300M1-P01 is a color active matrix liquid crystal display (LCD) that uses amorphous silicon TFT (Thin Film Transistor) as switching components. This model is composed of a TFT LCD panel, a driver circuit and a back light unit. The resolution of a 30.0" is 2560 x 1600 and this model can display up to 16.7 millions colors.

Features

- High contrast ratio & high aperture structure
- High speed response
- WQXGA (2560 x 1600 pixels) resolution
- S-PVA (Super Patterned Vertical Alignment) mode
- Direct BLU Structure (Cold Cathod Fluorescent Tube)
- Sync & DE(Data Enable) mode
- Dual Link TMDS serial interface (4pixel/clock)
- RoHS compliance
- Pb-free compliance

Applications

- Workstation & desktop monitors
- Display terminals for AV application products
- Monitors for industrial machine
- HDTV, medical machine

* If the module is used to other applications besides the above, please contact SEC in advance.

General Information

Items	Specification	Unit	Note
Pixel Pitch	0.2505(H) x 0.2505(W)	mm	
Active Display Area	641.28(H) x 400.8(V)	mm	
Surface Treatment	Haze 44% , Hard-coating (3H)		
Display Colors	8 bit - 16.7M	colors	
Number of Pixels	2,560 x 1,600	pixel	
Pixel Arrangement	RGB vertical stripe		
Display Mode	Normally Black		
Luminance of White	400	cd/m ²	typ

Mechanical Information

Item		Min.	Typ.	Max.	Unit	Note
Module size	Horizontal (H)	-	677.3	-	mm	w/o inverter ass'y
	Vertical (V)	-	436.8	-	mm	
	Depth (D)	-	-	42.3	mm	w/ inverter ass'y
Weight		-	-	-	kg	LCD module only
		-	-	4.9	Kg	w/ Inverter assembly

Note (1) Mechanical tolerance is $\pm 0.5\text{mm}$ unless there is a special comment.

1. Absolute Maximum Ratings

If the condition exceeds maximum ratings, it can cause malfunction or unrecoverable damage to the device.

Item	Symbol	Min.	Max.	Unit	Note
Power Supply Voltage	V_{DD}	GND-0.3	21.0	V	
Storage temperature	T_{STG}	-25	60	°C	(1)
Glass surface temperature (Operation)	T_{OPR}	0	50	°C	
Shock (non - operating)	S_{nop}	-	50	G	(2)
Vibration (non - operating)	V_{nop}	-	1.5	G	(3)

Note (1) $T_a = 25 \pm 2 \text{ }^\circ\text{C}$

- (1) Temperature and relative humidity range are shown in the figure below.
 - a. 90 % RH Max. ($T_a \leq 39 \text{ }^\circ\text{C}$)
 - b. Maximum wet-bulb temperature at $39 \text{ }^\circ\text{C}$ or less. ($T_a \leq 39 \text{ }^\circ\text{C}$)
 - c. No condensation
- (2) 11ms, sine wave, one time for $\pm X, \pm Y, \pm Z$ axis
- (3) 10-300 Hz, Sweep rate 10min, 30min for X,Y,Z axis

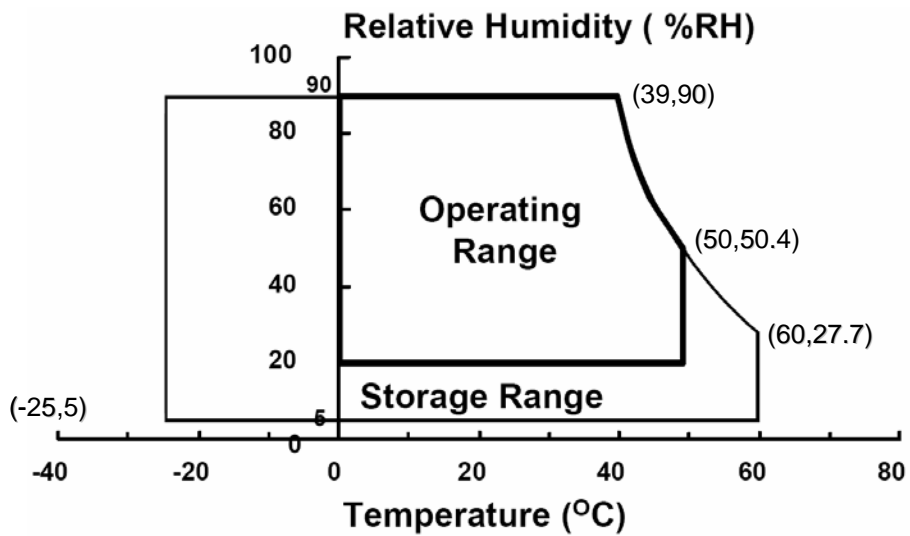

Fig. Temperature and Relative humidity range

2. Optical Characteristics

The optical characteristics should be measured in a dark room or equivalent.

Measuring equipment : TOPCON BM-7, SPECTRORADIOMETER SR-3

(Ta = 25 ± 2°C, VDD=18V, fv= 60Hz, fDCLK=134.25MHz, IL = 6.0mArms)

Item	Symbol	Condition	Min.	Typ.	Max.	Unit	Note	
Contrast Ratio (Center of screen)	C/R		500	900	-		(3) SR-3	
Response Time	On/Off	Tr + Tf	-	12	18	msec	(5) BM-7	
	G-To-G	T _{G-G,AVG}	-	6	-	msec	BM-7	
Luminance of White (Center of screen)	Y _L		350	400	-	cd/m ²	(6) SR-3	
Color Chromaticity (CIE 1931)	Red	Rx	-	0.640	-		(7),(8) SR-3	
		Ry	-	0.330	-			
	Green	Gx	-	0.300	-			
		Gy	-	0.608	-			
	Blue	Bx	-	0.150	-			
		By	-	0.060	-			
	White	Wx	-	0.313	-			
		Wy		0.329				
	Color Chromaticity (CIE 1976)	Red	Ru'	-	0.459	-		
			Rv'	-	0.525	-		
Green		Gu'	-	0.125	-			
		Gv'	-	0.563	-			
Blue		Bu'	-	0.164	-			
		Bv'	-	0.197	-			
White		Wu'	-	0.198	-			
		Wv'	-	0.468	-			
C.G.L	White	Δ u'v'	-	-	0.02		(9)	

* C.G.L : Color Grayscale Linearity

(continue to the next page)

Item	Symbol	Condition	Min.	Typ.	Max.	Unit	Note
Color Gamut	-		-	72	-	%	
Color Temperature	-		-	6500	-	K	
Viewing Angle	Hor.	θ_L	80	89	-	Degrees	(8) SR-3
		θ_R	80	89	-		
	Ver.	θ_U	80	89	-		
		θ_D	80	89	-		
Viewing Angle	Hor.	θ_L	-	75	-	Degrees	(8) SR-3
		θ_R	-	75	-		
	Ver.	θ_U	-	65	-		
		θ_D	-	65	-		
Brightness Uniformity (13 Points)	B_{uni}		-	-	25	%	(4) SR-3

Note (1) Test Equipment Setup

The measurement should be executed in a stable, windless and dark room between 30min after lighting the back light at the given temperature for stabilization of the back light. This should be measured in the center of screen.

Single lamp current : 6.0mA

Environment condition : $T_a = 25 \pm 2 \text{ }^\circ\text{C}$

Photo detector	Field
SR-3	1°
BM-7	2°

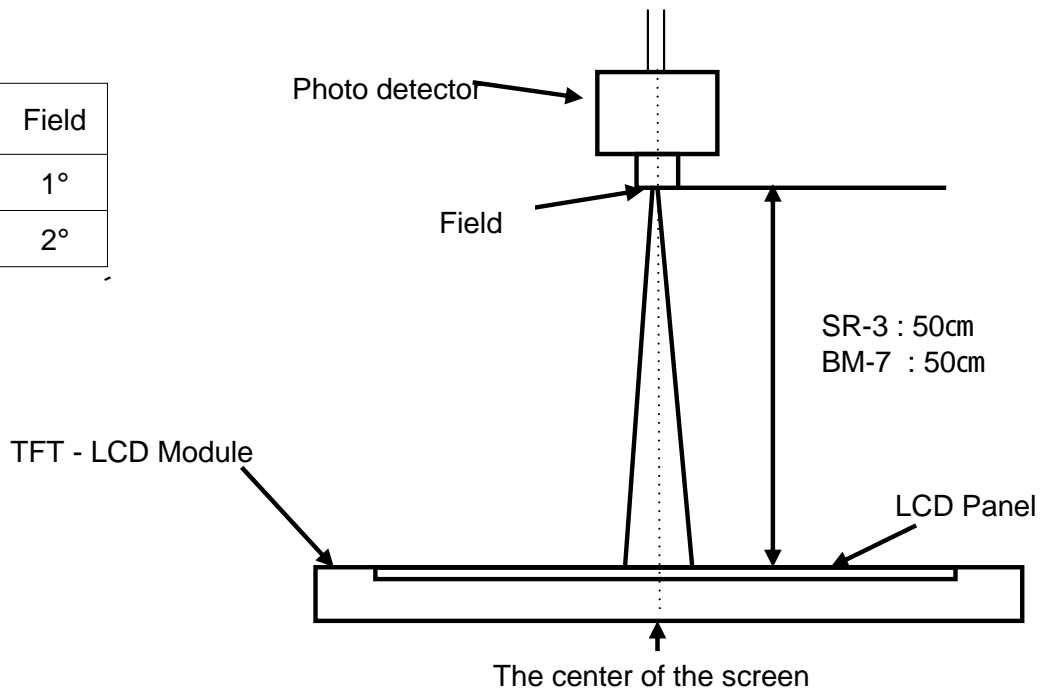

Note (2) Definition of test point

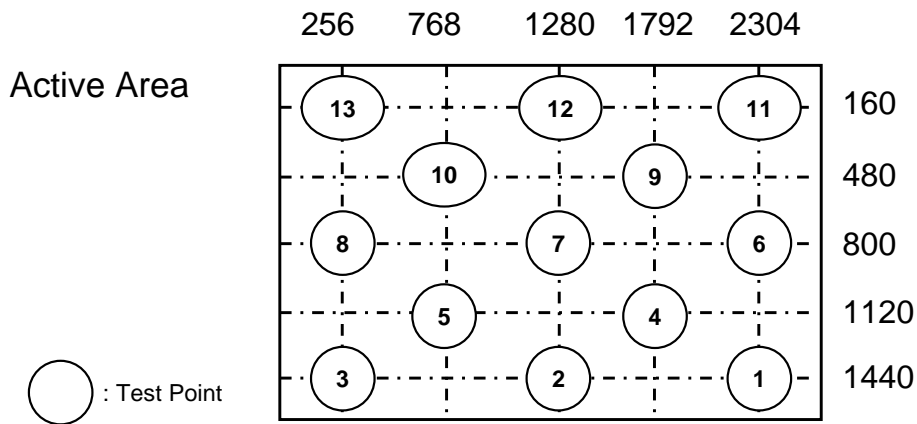

Note (3) Definition of Contrast Ratio (C/R)

: Ratio of gray max (Gmax) & gray min (Gmin) at the center point ⑦ of the panel

$$CR = \frac{G \max}{G \min}$$

Gmax : Luminance with all pixels white

Gmin : Luminance with all pixels black

Note (4) Definition of 13 points brightness uniformity(100% White)

$$Buni = 100 \times \frac{(B \max - B \min)}{B \max}$$

Bmax : Maximum brightness

Bmin : Minimum brightness

Note (5) Definition of Response time

a. On/Off response time : Sum of T_r , T_f

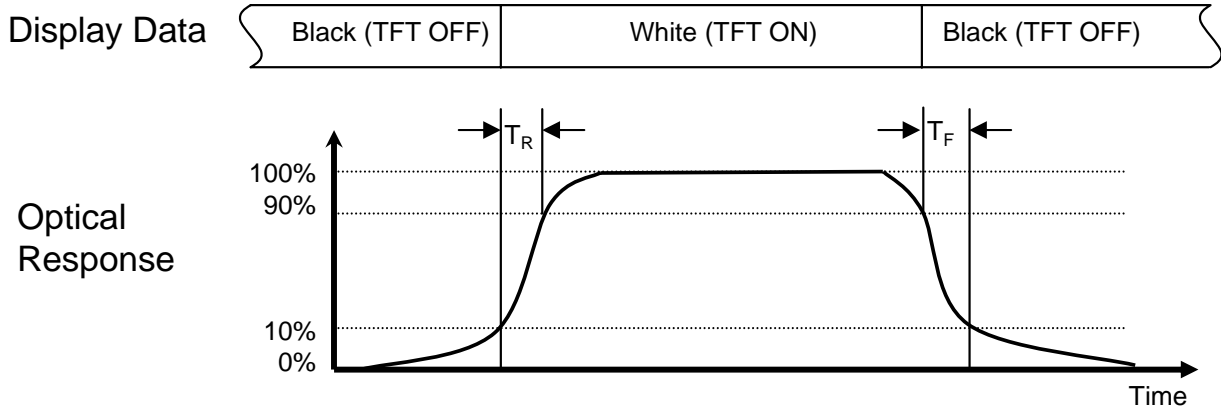

b. Gray to Gray Response Time

- Measuring gray : 31 → 63, 63 → 95, 95 → 127, 127 → 159, 159 → 191, 191 → 223
grays and vice versa

- $T_{G-G, avg}$: Average response time of ones between above grays

(Example)

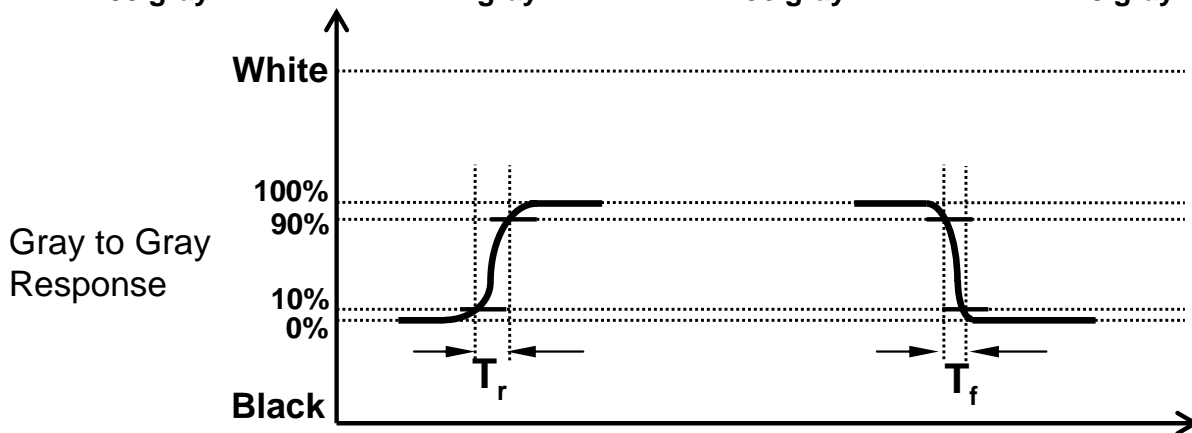

Note (6) Definition of Luminance of White : Luminance of white at center point^⑤

Note (7) Definition of Color Chromaticity (CIE 1931, CIE1976)
 Color coordinate of Red, Green, Blue & White at center point^⑤

Note (8) Definition of Viewing Angle
 : Viewing angle range ($CR \geq 10$, $CR \geq 100$)

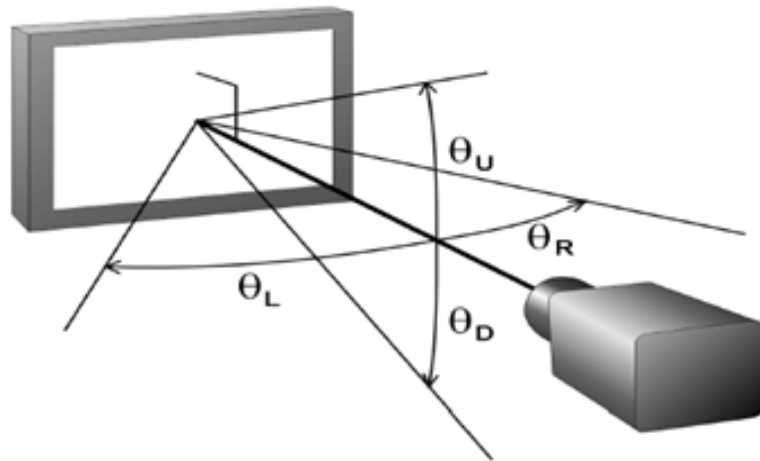

Note (9) Color Grayscale Linearity

- a. Test image : 100% full white pattern with a test pattern as below
- b. Test pattern : Squares, 40mm by 40mm in size, filled with 255, 225, 195, 165, 135 and 105 grays steps should be arranged at the center^⑤ of the screen.



c. Test method

- 1st gray step : move a square of 255 gray level should be moved into the center of the screen and measure luminance and u' and v' coordinates.
- Next gray step : Move a 225 gray square into the center and measure both luminance and coordinates, too.

d. Test evaluation

$$\Delta u'v' = \sqrt{(u'_A - u'_B)^2 + (v'_A - v'_B)^2}$$

Where A, B : 2 gray levels found to have the largest color differences between them
 i.e. get the largest $\Delta u'$ and $\Delta v'$ of each 6 pair of u' and v' and calculate the $\Delta u'v'$.

3. Electrical Characteristics

3.1 TFT LCD Module

The connector for display data & timing signal should be connected.

Ta = 25°C

Item		Symbol	Min.	Typ.	Max.	Unit	Note
Voltage of Power Supply		V_{DD}	17	18	19	V	(1)
Interface Type		Dual Link TMDS	TMDS (Sil178 or Sil170 TX)				
Current of Power Supply	(a) Black	I_{DD}	-	750	900	mA	(2)
	(b) White		-	1,000	1,200	mA	
	(c) Dot		-	1,150	1,250	mA	
Vsync Frequency		f_V	-	59.97	-	Hz	2pxl/clock
Hsync Frequency		f_H	-	98.713	-	kHz	
Main Frequency		f_{DCLK}	-	134.25	-	MHz	
Vsync Frequency		f_V	-	59.91	-	Hz	1pxl/clock
Hsync Frequency		f_H	-	49.31	-	kHz	
Main Frequency		f_{DCLK}	-	71.0	-	MHz	
Rush Current		I_{RUSH}	-	-	3.0	A	(3)

Note (1) The ripple voltage should be controlled under 10% of V_{DD} .

- (1) $f_V=60\text{Hz}$, $f_{\text{DCLK}}=134.25\text{MHz}$, $V_{\text{DD}}=18.0\text{V}$, DC Current.
- (2) Power dissipation check pattern (LCD Module only)

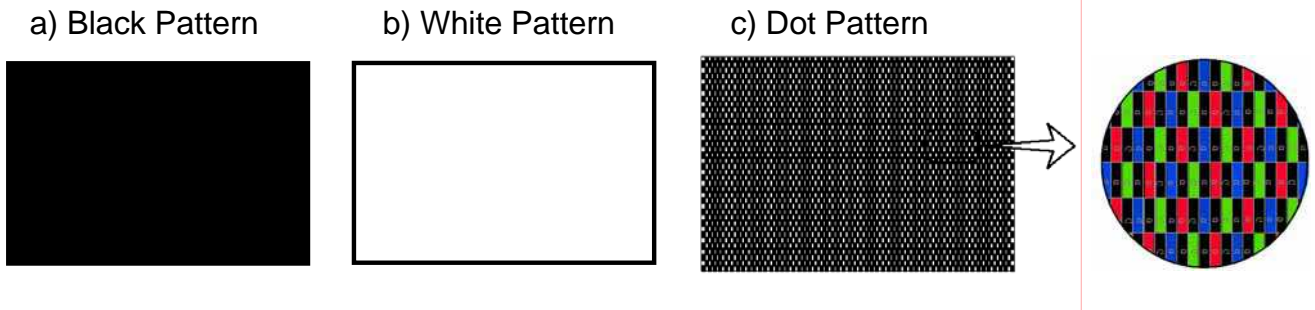

(3) Measurement Condition

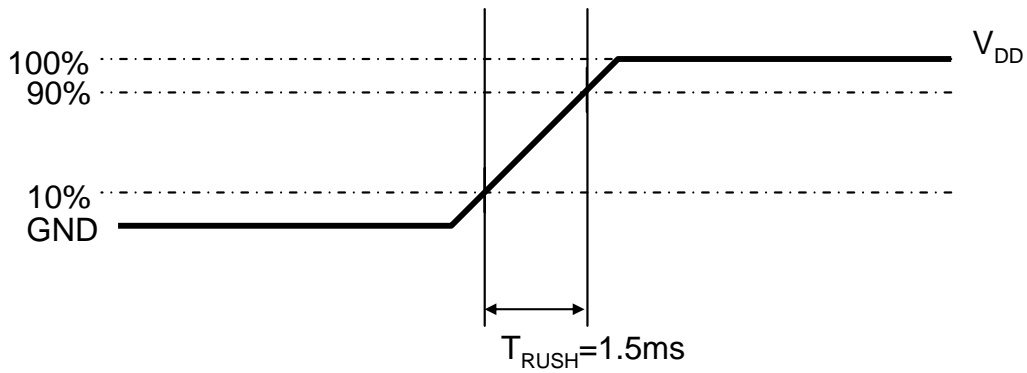

Rush Current I_{RUSH} can be measured when T_{RUSH} is 1.5ms.

3.2 Back Light Unit

The back light unit is a direct type 16 CCFTs (Cold Cathode Fluorescent Tube)
 The characteristics of lamps are shown in the following tables.

Ta=25 ± 2°C

Item	Symbol	Min.	Typ.	Max.	Unit	Note
Lamp Current	I_L	4.0	6.0	7.5	mArms	(1)
Lamp Voltage	V_L	-	1120	-	Vrms	
Lamp Frequency	f_L	40	-	60	kHz	(2)
Operating Life Time	Hr	50,000	-	-	Hour	(3)
Startup Voltage	V_s	-	0°C : 1,850		Vrms	(5)
			25°C: 1,700			

Note (1) Specified values are for a single lamp.

Lamp current is measured with current meter for high frequency as shown below.

Refer to the following block diagram of the back light unit for more information.

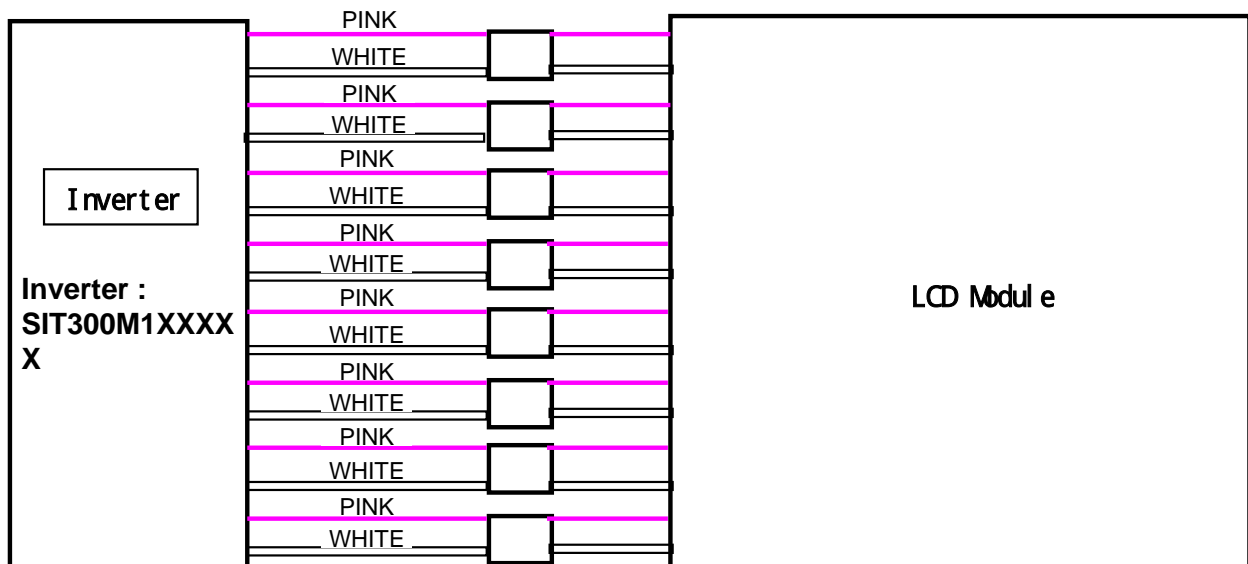

Fig. Measurement point of Lamp Current

(2) Lamp frequency which may produce interference with horizontal synchronous frequency may cause line flow on the display. Therefore lamp frequency should be detached from the horizontal synchronous frequency and its harmonics as far as possible in order to avoid interference.

(3) Life time (Hr) is defined as the time when brightness of a lamp unit itself becomes 50% or less than its original value at the condition of $T_a = 25 \pm 2^\circ\text{C}$ and $I_L = 6.0\text{mA rms}$

(4) If an inverter has shutdown function, it should keep its output for over 1 second even if the lamp connector is open. Otherwise the lamps may not be turned on.

3.3 Inverter Specification

No.	Item	SYM	Condition	Min.	Typ.	Max.	Unit
1	Input Voltage	V_{IN}	-	21.6	24.0	26.4	V
2	Input Current	I_{IN}	Vin=24V, V_{ADIM} =2.8V			7	A
			After 1 Hour Aging		3.5		
3	Output Current	I_{OMAX}	Vin=24V, V_{ADIM} : 2.8V	5.5	6.0	6.5	mArms
		I_{OMIN}	Vin=24V, V_{ADIM} : 0.0V	3.0	3.5	4.0	
4	Lamp Frequency	f_0	V_{IN} =24V	55	60	65	KHz
5	Backlight ON/OFF Control	ON	-	2.4		5.25	V
		OFF	-	0		0.8	
6	Analog Mode Signal	V_{ADIM}	V_{IN} =24V	0		2.8	V
7	Open Lamp Voltage	V_{OPEN}	V_{IN} =24V, PWM Duty=100% Each Transformer Output	1850			Vrms
8	PWM Frequency	f_{PWM}	V_{IN} =24V	140	150	160	Hz
9	Shutdown time	T_{SD}	V_{IN} =24V	1.0	1.5	2.0	sec

(Note)

- Open Lamp voltage measurement
 - Vopen : All output connectors open, then two voltage probe touch on one lamp output terminals simultaneously
 - One wire open voltage : One wire of lamp open, then two voltage probes touch on one lamp output terminals simultaneously
- ※ The open lamp voltage indicates the secondary voltage of Transformer.
in case of open lamp voltage-measurement, They must be tested simultaneously.

4. BLOCK DIAGRAM

4.1 TFT LCD Module

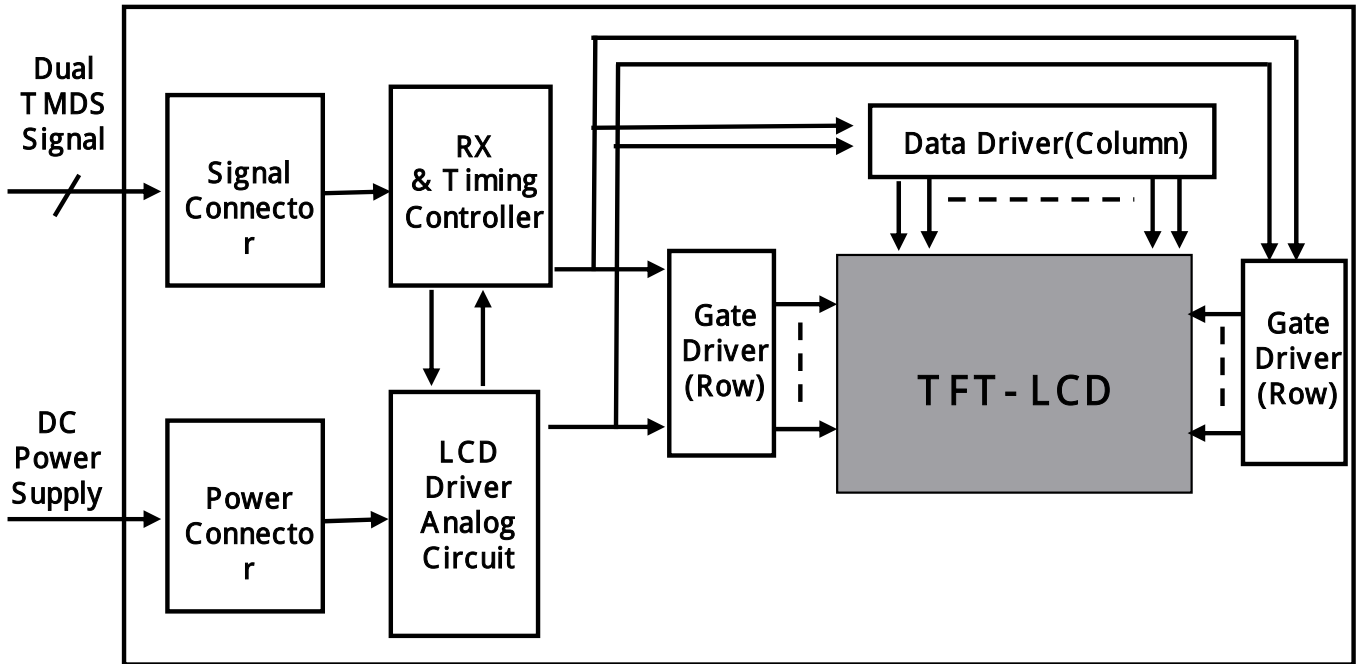

4.2 Back Light Unit

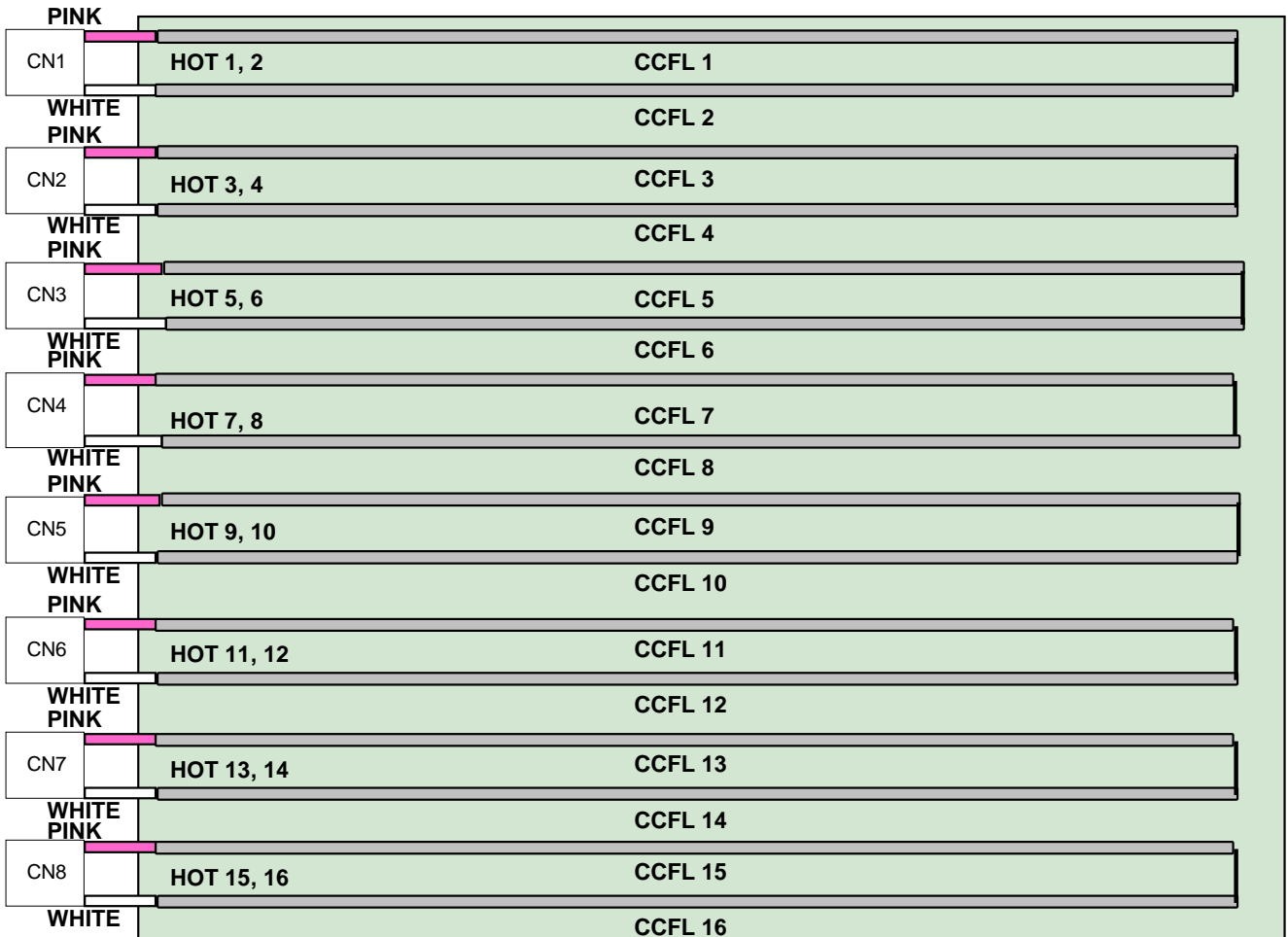

5. Input Terminal Pin Assignment

5.1.1 Input Signal (Connector : IS100-L300-C23 or Compatible)

PIN No	Symbol	Description	PIN No	Symbol	Description
1	NC	CTL (Internal Only)	16	RxC+	TMDS Negative differential output (channel C)
2	NC	CE (Internal Only)	17	SHLD5	Shield for TMDS Channel 5
3	NC	NC	18	Rx5+	TMDS Positive differential output (channel 5)
4	NC	NC	19	Rx5-	TMDS Negative differential output (channel 5)
5	SHLD2	Shield for TMDS Channel 2	20	SHLD4	Shield for TMDS Channel 4
6	Rx2+	TMDS Positive differential output (channel 2)	21	Rx4+	TMDS Positive differential output (channel 4)
7	Rx2-	TMDS Negative differential output (channel 2)	22	Rx4-	TMDS Negative differential output (channel 4)
8	SHLD1	Shield for TMDS Channel 1	23	SHLD3	Shield for TMDS Channel 3
9	Rx1+	TMDS Positive differential output (channel 1)	24	Rx3+	TMDS Positive differential output (channel 3)
10	Rx1-	TMDS Negative differential output (channel 1)	25	Rx3-	TMDS Negative differential output (channel 3)
11	SHLD0	Shield for TMDS Channel 0	26	NC	NC
12	Rx0+	TMDS Positive differential output (channel 0)	27	NC	NC
13	Rx0-	TMDS Negative differential output (channel 0)	28	NC	NC
14	SHLDC	Shield for TMDS Channel C	29	NC	NC
15	RxC+	TMDS Positive differential output (channel C)	30	NC	NC

* If the system already uses the 1, 2 pins, it should keep under GND level
The voltage applied to those pins should not exceed -200mV.

5.1.2. Input Power

- 1) Connector (Receptacle) : 53261 (Molex) of Equivalent.
- 2) Mating Connector (Plug) : 51021 or its equivalent.

PIN No	Symbol	Description	Notes
1	SDA	Si1169 HDCP program Mode Data	Pull Up 3.3V
2	SCL	Si1169 HDCP program Mode CLK	Pull Up 3.3V
3	PWR_ON	LCM On Control signal input	Pull Up 3.3V
4	GND	Ground	
5	Vlcd	LCM Power supply, +18V ± 5%	
6	Vlcd	LCM Power supply, +18V ± 5%	
7	Vlcd	LCM Power supply, +18V ± 5%	
8	Vlcd	LCM Power supply, +18V ± 5%	
9	GND	Ground	
10	HDCP_CLK	HDCP_Clock	Reserved
11	HDCP_DAT	HDCP_Data	Reserved
12	AGP	Auto generate pattern	Pull Up 3.3V
13	HS_OUT	Hsync Output	
14	VS_OUT	Vsync Output	
15	GND	Ground	

5.1.3. Inverter Input Connector : S14B-PHA-SM (JST) or Compatible.

Pin	Symbol	Description	Notes
1	V _{BL}	Power Supply, +24V	
2	V _{BL}	Power Supply, +24V	
3	V _{BL}	Power Supply, +24V	
4	V _{BL}	Power Supply, +24V	
5	V _{BL}	Power Supply, +24V	
6	GND	Power Ground	
7	GND	Power Ground	
8	GND	Power Ground	
9	GND	Power Ground	
10	GND	Power Ground	
11	VS	No connection	
12	V _{ON}	BL On/Off Control signal	ON : 2.4V~ 5.25V OFF : 0.0~ 0.8V
13	V _{BR}	PWM Dimming Control Signal	Max2.8V / Min(0.0)V
14	Status	Lamp Operating Status	Normal =0~ 0.8V Abnormal=3.0~ 5.0V

Note) Pin number starts from Right side

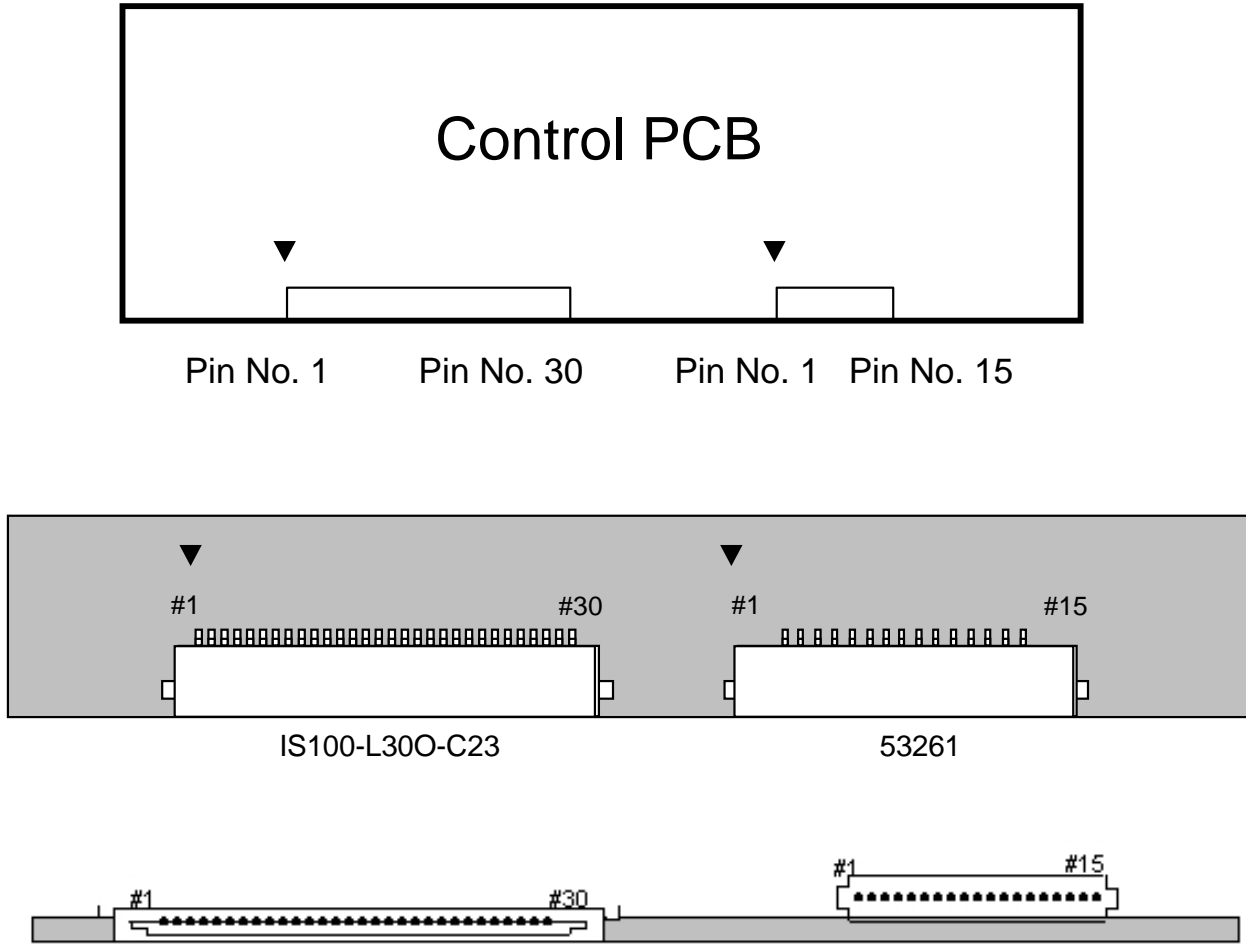

Fig. Connector diagram

- a. All GND pins should be connected together and also be connected to the LCD's metal chassis.
- b. All power input pins should be connected together.
- c. All NC pins should be separated from other signal or power.

5.2 Back Light Unit

Pin No.	Input	Color	Function
1-1	HOT	PINK	High Voltage
1-2	HOT	WHITE	High Voltage
2-1	HOT	PINK	High Voltage
2-2	HOT	WHITE	High Voltage
3-1	HOT	PINK	High Voltage
3-2	HOT	WHITE	High Voltage
4-1	HOT	PINK	High Voltage
4-2	HOT	WHITE	High Voltage
5-1	HOT	PINK	High Voltage
5-2	HOT	WHITE	High Voltage
6-1	HOT	PINK	High Voltage
6-2	HOT	WHITE	High Voltage
7-1	HOT	PINK	High Voltage
7-2	HOT	WHITE	High Voltage
8-1	HOT	PINK	High Voltage
8-2	HOT	WHITE	High Voltage
Connector Part No.	20022WR-14(L)(Yeonho) or Compatible.		

5.3 Input Signals, Basic Display Colors and Gray Scale of Each Color

COLOR	DISPLAY (8bit)	DATA SIGNAL																								GRAY SCALE LEVEL
		RED								GREEN								BLUE								
		R0	R1	R2	R3	R4	R5	R6	R7	G0	G1	G2	G3	G4	G5	G6	G7	B0	B1	B2	B3	B4	B5	B6	B7	
BASIC COLOR	BLACK	0	0	0	0	0	0	0	0	0	0	0	0	0	0	0	0	0	0	0	0	0	0	0	0	-
	BLUE	0	0	0	0	0	0	0	0	0	0	0	0	0	0	0	0	1	1	1	1	1	1	1	1	-
	GREEN	0	0	0	0	0	0	0	0	1	1	1	1	1	1	1	1	0	0	0	0	0	0	0	0	-
	CYAN	0	0	0	0	0	0	0	0	1	1	1	1	1	1	1	1	1	1	1	1	1	1	1	1	-
	RED	1	1	1	1	1	1	1	1	0	0	0	0	0	0	0	0	0	0	0	0	0	0	0	0	-
	MAGENTA	1	1	1	1	1	1	1	1	0	0	0	0	0	0	0	0	1	1	1	1	1	1	1	1	-
	YELLOW	1	1	1	1	1	1	1	1	1	1	1	1	1	1	1	1	0	0	0	0	0	0	0	0	-
	WHITE	1	1	1	1	1	1	1	1	1	1	1	1	1	1	1	1	1	1	1	1	1	1	1	1	-
GRAY SCALE OF RED	BLACK	0	0	0	0	0	0	0	0	0	0	0	0	0	0	0	0	0	0	0	0	0	0	0	R0	
	DARK ↑	1	0	0	0	0	0	0	0	0	0	0	0	0	0	0	0	0	0	0	0	0	0	0	R1	
		0	1	0	0	0	0	0	0	0	0	0	0	0	0	0	0	0	0	0	0	0	0	0	R2	
		:	:	:	:	:	:	:	:	:	:	:	:	:	:	:	:	:	:	:	:	:	:	:	R3~R252	
		:	:	:	:	:	:	:	:	:	:	:	:	:	:	:	:	:	:	:	:	:	:	:		
	LIGHT ↓	1	0	1	1	1	1	1	1	0	0	0	0	0	0	0	0	0	0	0	0	0	0	0	R253	
		0	1	1	1	1	1	1	1	0	0	0	0	0	0	0	0	0	0	0	0	0	0	0	R254	
	RED	1	1	1	1	1	1	1	1	0	0	0	0	0	0	0	0	0	0	0	0	0	0	0	R255	
GRAY SCALE OF GREEN	BLACK	0	0	0	0	0	0	0	0	0	0	0	0	0	0	0	0	0	0	0	0	0	0	0	G0	
	DARK ↑	0	0	0	0	0	0	0	0	1	0	0	0	0	0	0	0	0	0	0	0	0	0	0	G1	
		0	0	0	0	0	0	0	0	0	1	0	0	0	0	0	0	0	0	0	0	0	0	0	G2	
		:	:	:	:	:	:	:	:	:	:	:	:	:	:	:	:	:	:	:	:	:	:	:	G3~G252	
		:	:	:	:	:	:	:	:	:	:	:	:	:	:	:	:	:	:	:	:	:	:	:		
	LIGHT ↓	0	0	0	0	0	0	0	0	1	0	1	1	1	1	1	1	0	0	0	0	0	0	0	G253	
		0	0	0	0	0	0	0	0	0	1	1	1	1	1	1	1	0	0	0	0	0	0	0	G254	
	GREEN	0	0	0	0	0	0	0	0	1	1	1	1	1	1	1	1	0	0	0	0	0	0	0	G255	
GRAY SCALE OF BLUE	BLACK	0	0	0	0	0	0	0	0	0	0	0	0	0	0	0	0	0	0	0	0	0	0	0	B0	
	DARK ↑	0	0	0	0	0	0	0	0	0	0	0	0	0	0	0	0	1	0	0	0	0	0	0	B1	
		0	0	0	0	0	0	0	0	0	0	0	0	0	0	0	0	0	1	0	0	0	0	0	B2	
		:	:	:	:	:	:	:	:	:	:	:	:	:	:	:	:	:	:	:	:	:	:	:	B3~B252	
		:	:	:	:	:	:	:	:	:	:	:	:	:	:	:	:	:	:	:	:	:	:	:		
	LIGHT ↓	0	0	0	0	0	0	0	0	0	0	0	0	0	0	0	0	1	0	1	1	1	1	1	B253	
		0	0	0	0	0	0	0	0	0	0	0	0	0	0	0	0	0	1	1	1	1	1	1	B254	
	BLUE	0	0	0	0	0	0	0	0	0	0	0	0	0	0	0	0	1	1	1	1	1	1	1	B255	

Note (1) Definition of Gray :

Rn : Red Gray, Gn : Green Gray, Bn : Blue Gray (n = Gray level)

Input Signal : 0 = Low level voltage, 1 = High level voltage

6. Interface Timing

6.1 Timing Parameters (Dual Mode : 2,560*1,600)

2pxl/ clk

SIGNAL	ITEM	SYMBOL	MIN.	TYP.	MAX.	UNIT	NOTE
Clock	Frequency	$1/T_C$	134.25	134.25	134.25	MHz	(1),(2)
	High Time	T_{CH}	3.725	3.725	3.725	nsec	
	Low Time	T_{CL}	3.725	3.725	3.725	nsec	
Data Enable	Setup Time	T_{ES}	-	-	-	nsec	
Frame Frequency	Cycle	T_V	16.7	16.7	16.7	msec	
			1646	1646	1646	lines	
One Line Scanning Time	Cycle	T_H	2720	2720	2720	clocks	
Vertical Active Display Term	Display Period	T_{VD}	1600	1600	1600	lines	
	VSync Width	T_{VW}	6	6	6	lines	①
	Vertical Front Porch	T_{VFP}	3	3	3	lines	②
	Vertical Back Porch	T_{VBP}	37	37	37	lines	③
	Vertical Blank Period	T_{VB}	46	46	46	lines	①+②+③
Horizontal Active Display Term	Display Period	T_{HD}	1280	1280	1280	clocks	2pixel/clock (3)
			2560	2560	2560	pixels	
	HSync Width	T_{HW}	32	32	32	pixels	④
	Horizontal Front Porch	T_{HBP}	48	48	48	pixels	⑤
	Horizontal Back Porch	T_{HFP}	80	80	80	pixels	⑥
	Horizontal Blank Period	T_{HBP}	160	160	160	pixels	④+⑤+⑥

Note 1) Test Point : TTL control signal and CLK at TMD5 Tx input terminal in system

Note 2) Internal VCC 3.3 V

Note 3) DE Signal should have a same period.

Note 4) VESA CVT SPEC (Reduced Blanking)

Note 5) VESA CVT Name : 4.10MA-R

6.2 Timing Parameters (Single Mode : 1,280*800)

1 pxI/ clk

SIGNAL	ITEM	SYMBOL	MIN.	TYP.	MAX.	UNIT	NOTE
Clock	Frequency	$1/T_C$	71	71	71	MHz	(1),(2)
	High Time	T_{CH}	7.04	7.04	7.04	nsec	
	Low Time	T_{CL}	7.04	7.04	7.04	nsec	
Data Enable	Setup Time	T_{ES}	-	-	-	nsec	
Frame Frequency	Cycle	T_V	16.7	16.7	16.7	msec	
			823	823	823	lines	
One Line Scanning Time	Cycle	T_H	1440	1440	1440	clocks	
Vertical Active Display Term	Display Period	T_{VD}	800	800	800	lines	
	VSync Width	T_{VW}	6	6	6	lines	①
	Vertical Front Porch	T_{VFP}	3	3	3	lines	②
	Vertical Back Porch	T_{VBP}	14	14	14	lines	③
	Vertical Blank Period	T_{VB}	23	23	23	lines	①+②+③
Horizontal Active Display Term	Display Period	T_{HD}	1280	1280	1280	clocks	1pixel/clock (3)
			1280	1280	1280	pixels	
	HSync Width	T_{HW}	32	32	32	pixels	④
	Horizontal Front Porch	T_{HFP}	48	48	48	pixels	⑤
	Horizontal Back Porch	T_{HBP}	80	80	80	pixels	⑥
	Horizontal Blank Period	T_{HBP}	160	160	160	pixels	④+⑤+⑥

Note 1) Test Point : TTL control signal and CLK at TMDS Tx input terminal in system

Note 2) Internal VCC 3.3 V

Note 3) DE Signal should have a same period.

Note 4) VESA CVT SPEC (Reduced Blanking)

Note 5) VESA CVT Name : 1.02MA-R

Note 6) To operate single mode, sil1169 should be programmed.

6.3 Timing diagrams of interface signal (DE only mode)

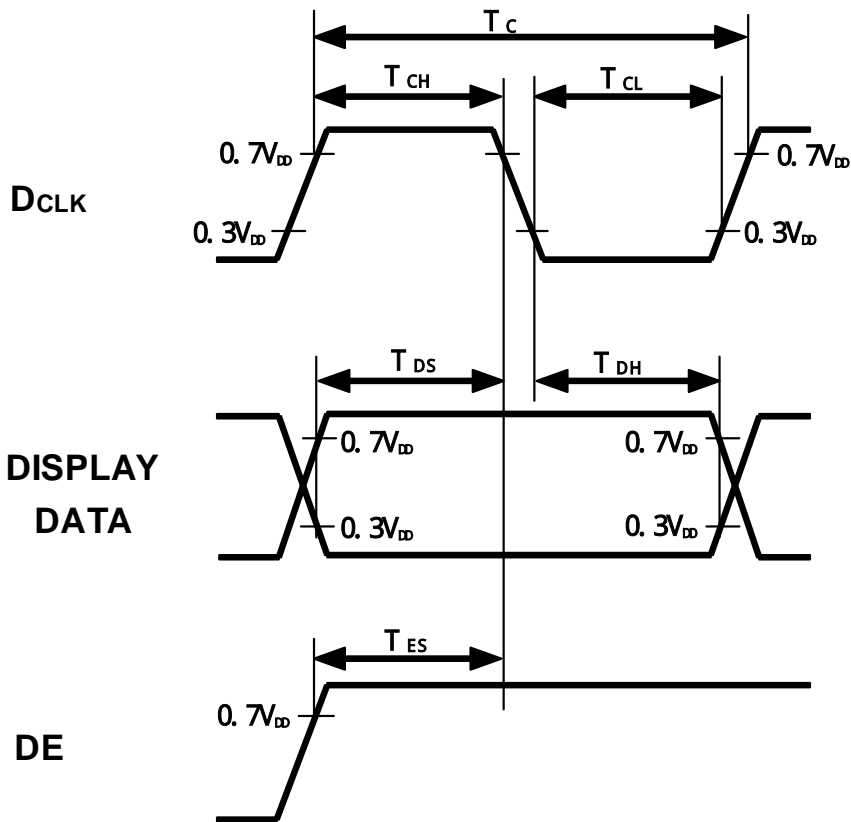
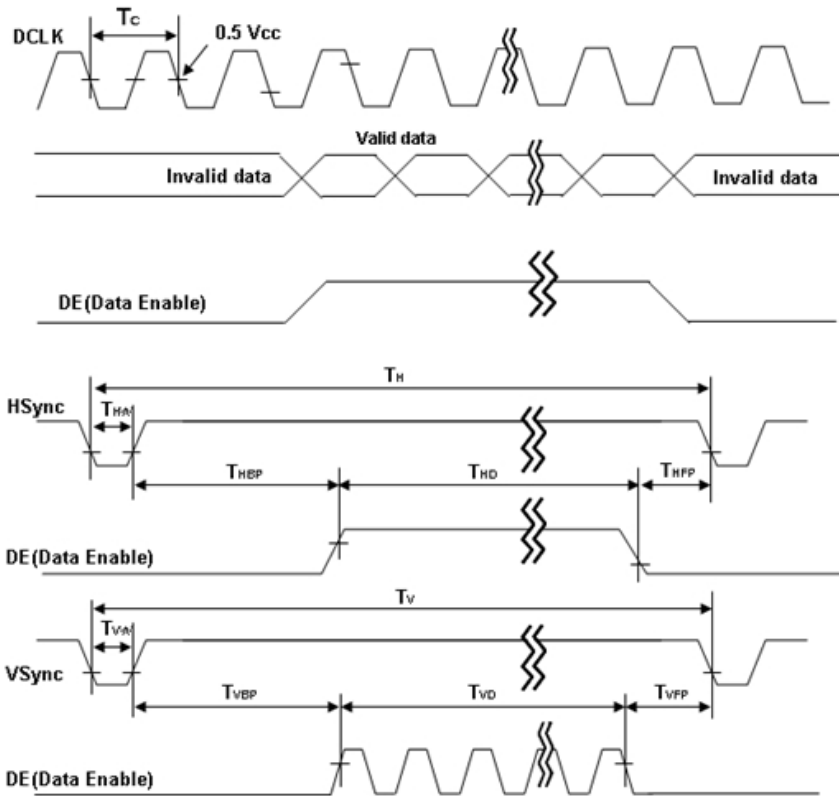

6.4 TMD5 Interface Timing Setting

Device	Pin Name	First Clock Edge	Second Clock Edge
Master SiI 178	D11	G0[3]	R0[7]
	D10	G0[2]	R0[6]
	D9	G0[1]	R0[5]
	D8	G0[0]	R0[4]
	D7	B0[7]	R0[3]
	D6	B0[6]	R0[2]
	D5	B0[5]	R0[1]
	D4	B0[4]	R0[0]
	D3	B0[3]	G0[7]
	D2	B0[2]	G0[6]
	D1	B0[1]	G0[5]
D0	B0[0]	G0[4]	
Slave SiI 178	D11	G1[3]	R1[7]
	D10	G1[2]	R1[6]
	D9	G1[1]	R1[5]
	D8	G1[0]	R1[4]
	D7	B1[7]	R1[3]
	D6	B1[6]	R1[2]
	D5	B1[5]	R1[1]
	D4	B1[4]	R1[0]
	D3	B1[3]	G1[7]
	D2	B1[2]	G1[6]
	D1	B1[1]	G1[5]
D0	B1[0]	G1[4]	

Notes

1. Color Pixel Components: R = RED, G = GREEN, B = BLUE
2. Bit significance within a color: [7:0] = [Msb:Lsb]

6.5 TMD5 Rx(SiI1169) Programming Mode Data

SiI 1169 Address	Master	Slave
09	07	07
0A	32	32
0B	08	08
0C	00	00
0D	05	45
0E	02	02
0F	5B	53

Note 1) For the Normal operating, LCM TMD5 Rx(SiI1169) should be programmed using the above programming mode data

Note 2) TMD5 Rx should be re-programmed each power on/off status.

Note 3) The above programming mode is recommended value.

if the different data is programmed, it may cause abnormal display or No Display.

6.6 TMD5 Rx(Sil1169) Input Skew : $T_{ccs} = \text{Max } 4\text{nS}$

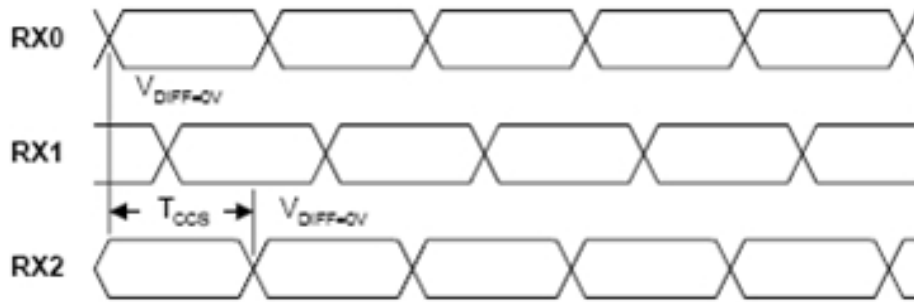

6.7 TMD5 Rx(Sil1169) I2C Data Valid Delay : $T_{i2cdvd} = \text{MAX } 700\text{nS}$

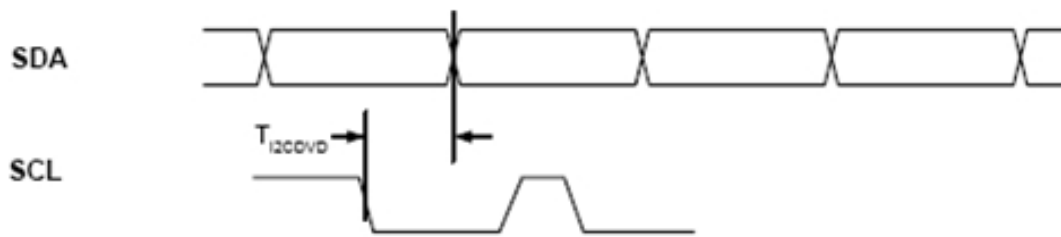

6.8 Power ON/OFF Sequence

To prevent a latch-up or DC operation of the LCD Module, the power on/off sequence should be as the diagram below.

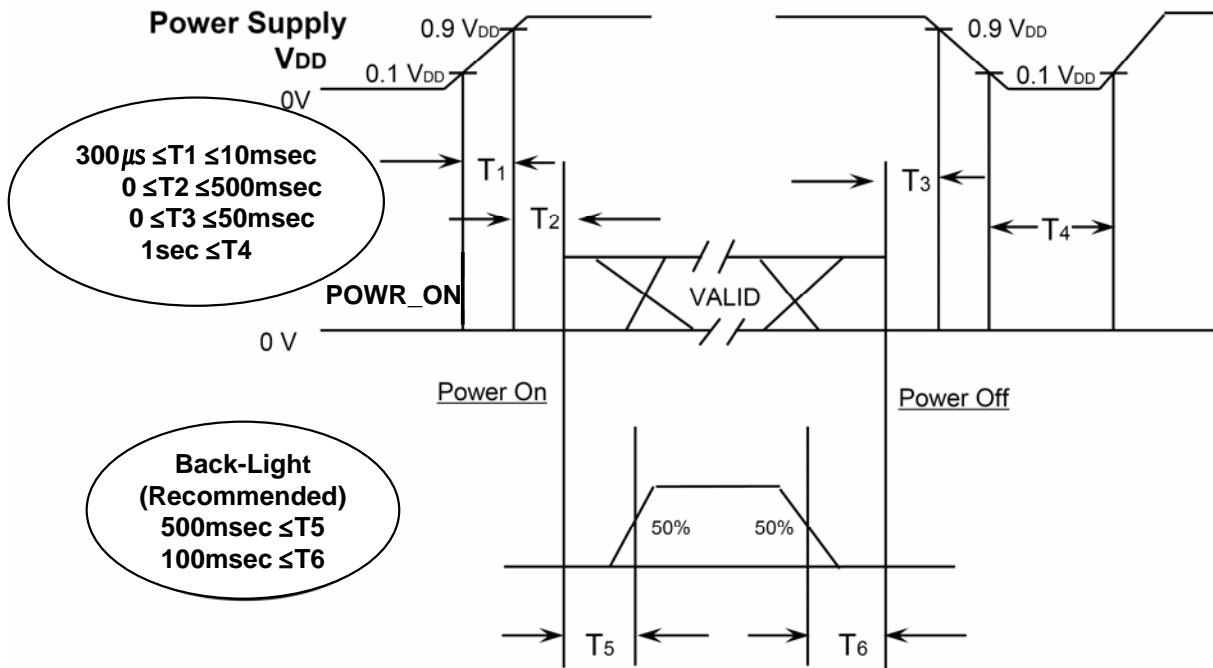

T1 : V_{DD} rising time from 10% to 90%

T2 : The time from V_{DD} to valid data at power ON.

T3 : The time from valid data off to V_{DD} off at power Off.

T4 : V_{DD} off time for Windows restart

T5 : The time from valid data to B/L enable at power ON.

T6 : The time from valid data off to B/L disable at power Off.

- The supply voltage of the external system for the Module input should be the same as the definition of V_{DD}.
- Apply the lamp voltage within the LCD operation range. When the back light turns on before the LCD operation or the LCD turns off before the back light turns off, the display may momentarily show abnormal screen.
- In case of V_{DD} = off level, please keep the level of input signals low or keep a high impedance.
- T4 should be measured after the Module has been fully discharged between power off and on period.
- Interface signal should not be kept at high impedance when the power is on.

6.9 Inverter Power Sequence

1) Rising Time of V_{IN}

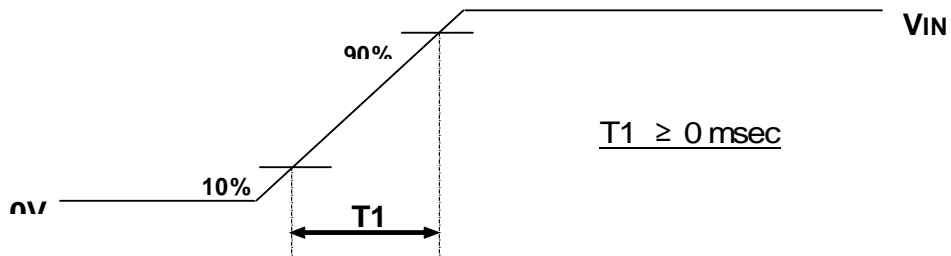

2) On/Off Sequence of V_{IN}

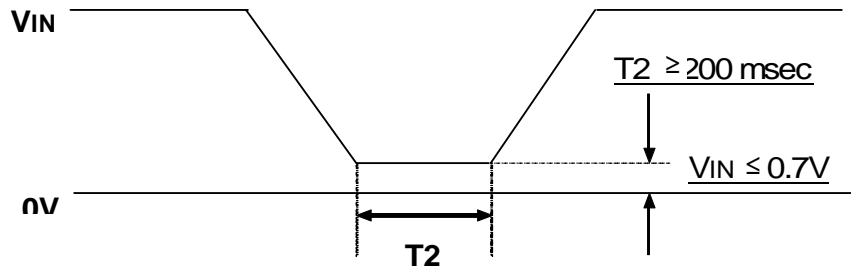

3) Power Sequence

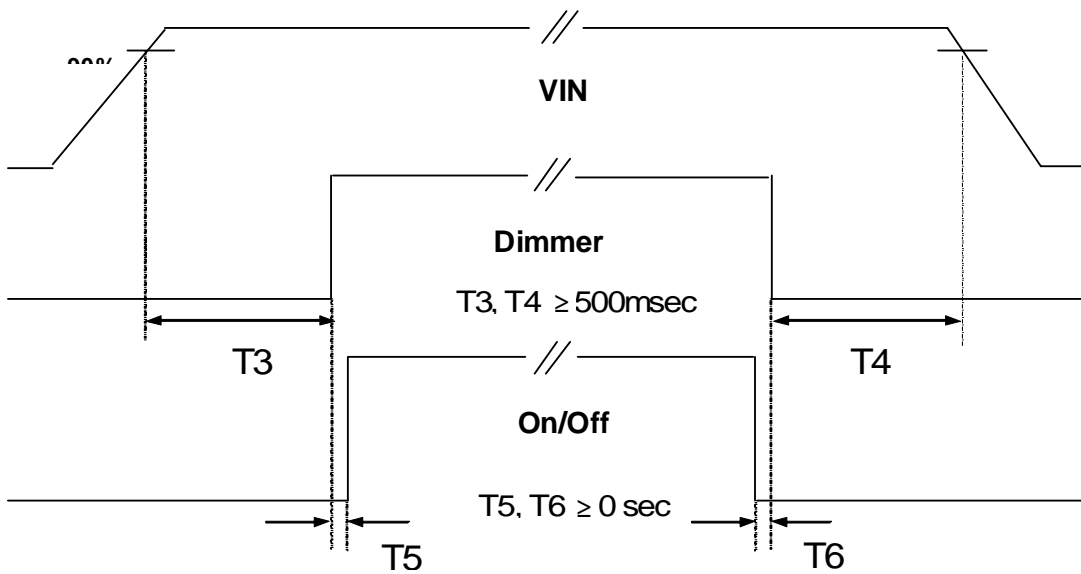

6.10 VDD Power Dip Condition

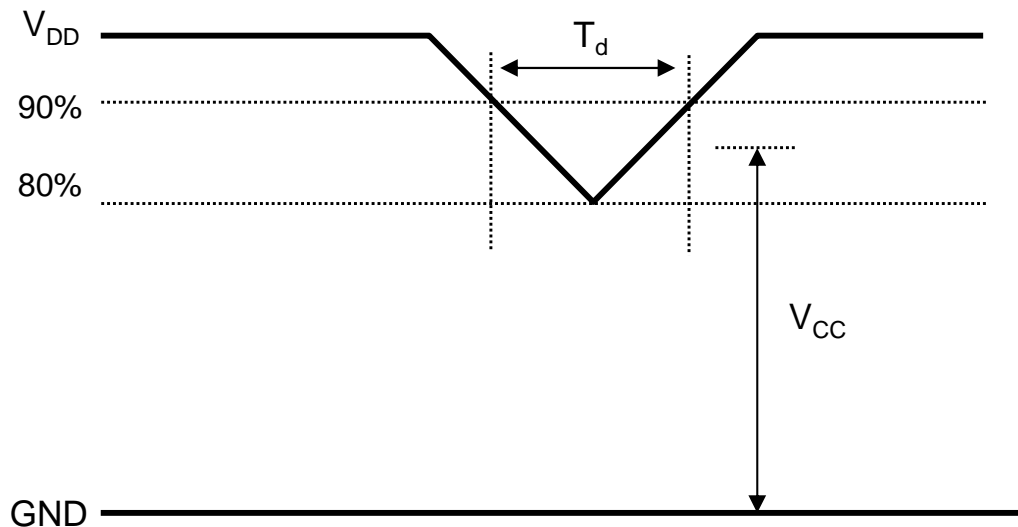

$17V \leq V_{DD} \leq 19V$
 If $V_{DD}(\text{typ.}) \times 80\% \leq V_{CC} \leq V_{DD}(\text{typ.}) \times 90\%$
 Then, $0 < T_d \leq 20\text{msec}$

- Note (1) The above conditions are for the glitch of the input voltage.
 (2) For stable operation of an LCD Module power, please follow them.
 i.e., if $\text{typ } V_{DD} \times 80\% \leq V_{cc} \leq \text{typ } V_{DD} \times 90\%$, then T_d should be less than 20ms.

7. Outline Dimension

[Refer to the next page]

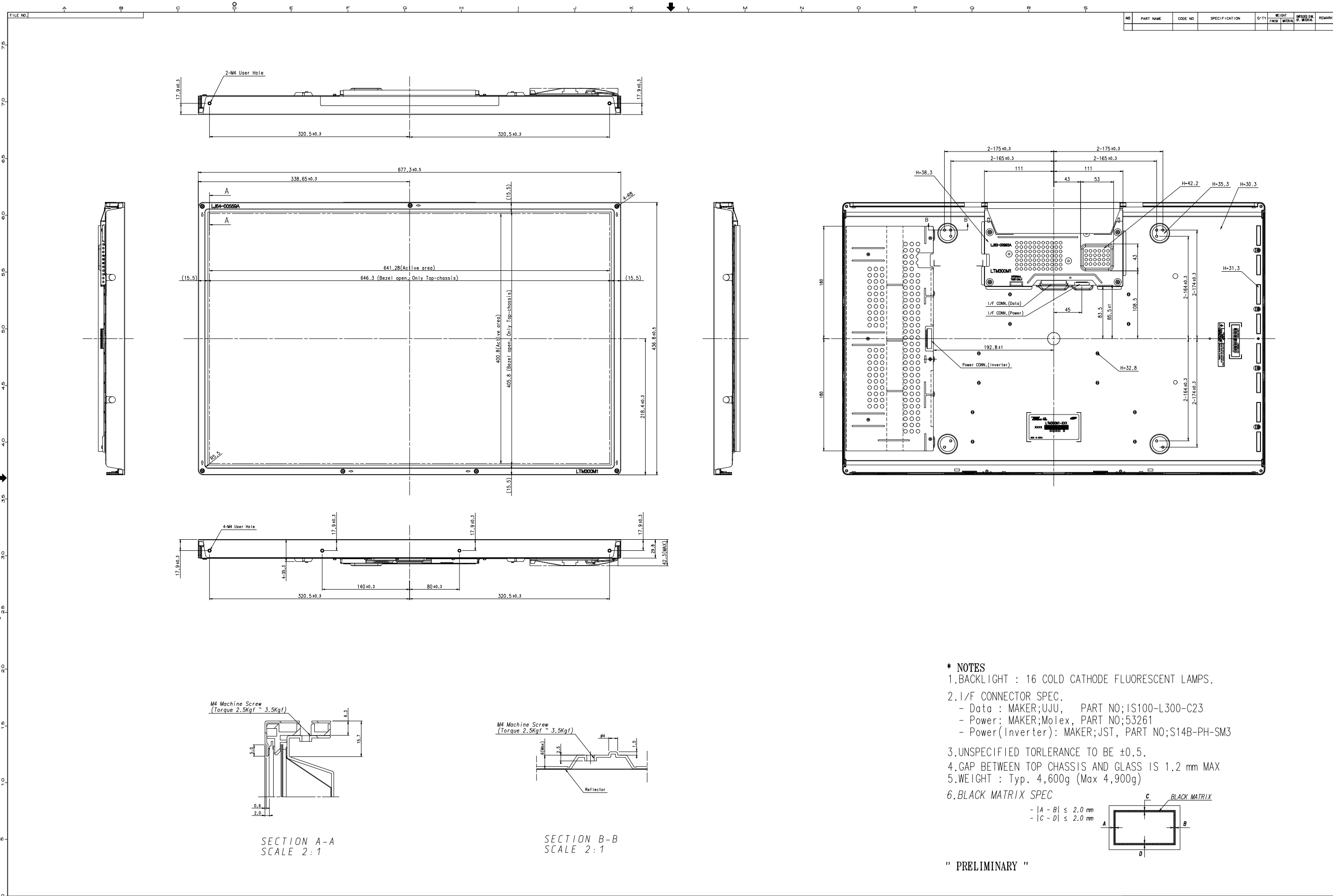

NO	PART NAME	CODE NO	SPECIFICATION	Q'TY	WEIGHT	REMARK

- * NOTES**
- BACKLIGHT : 16 COLD CATHODE FLUORESCENT LAMPS.
 - I/F CONNECTOR SPEC.
 - Data : MAKER;UJU, PART NO;IS100-L300-C23
 - Power : MAKER;Molex, PART NO;53261
 - Power(Inverter) : MAKER;JST, PART NO;S14B-PH-SM3
 - UNSPECIFIED TOLERANCE TO BE ± 0.5 .
 - GAP BETWEEN TOP CHASSIS AND GLASS IS 1.2 mm MAX
 - WEIGHT : Typ. 4,600g (Max 4,900g)
 - BLACK MATRIX SPEC
 - $|A - B| \leq 2.0 \text{ mm}$
 - $|C - D| \leq 2.0 \text{ mm}$

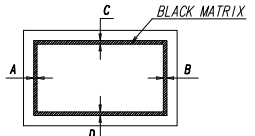

" PRELIMINARY "

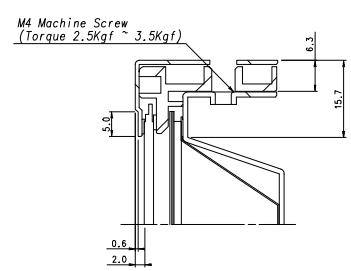

SECTION A-A
SCALE 2:1

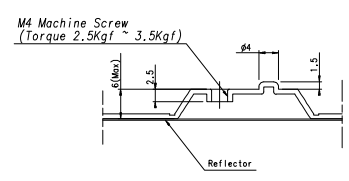

SECTION B-B
SCALE 2:1

STEP	GENERAL TOLERANCE				REV. DATE	DESCRIPTION OF REVISION	REASON	MODEL NAME	PART/SHEET NAME	SHEET
	LEVEL 1	LEVEL 2	LEVEL 3	LEVEL 4						
0	X	4	10.05	10.1	10.2			LTM300M1-P01	OUTLINE-DIM.	1/1
4	X	16	10.05	10.75	10.5					
16	X	64	10.12	10.25	10.5					
64	X	256	10.25	10.4	10.8					

SAMSUNG ELECTRONICS

8. General Precautions

8.1 Handling

- (a) When the module is assembled, it should be attached to the system firmly using all mounting holes. Be careful not to twist and bend the module.
- (b) Because the inverter uses high voltages, it should be disconnected from power source before it is assembled or disassembled.
- (c) Refrain from strong mechanical shock and / or any force to the module. In addition to damage, it may cause improper operation or damage to the module and CCFT back light.
- (d) Note that polarizer films are very fragile and could be damaged easily. Do not press or scratch the surface harder than a HB pencil lead.
- (e) Wipe off water droplets or oil immediately. If you leave the droplets for a long time, staining or discoloration may occur.
- (f) If the surface of the polarizer is dirty, clean it using absorbent cotton or soft cloth.
- (g) Desirable cleaners are water, IPA (Isopropyl Alcohol) or Hexane. Do not use Ketone type materials (ex. Acetone), Ethyl alcohol, Toluene, Ethyl acid or Methyl chloride. It might cause permanent damage to the polarizer due to chemical reaction.
- (h) If the liquid crystal material leaks from the panel, it should be kept away from the eyes or mouth . In case of contact with hands, legs or clothes, it must be washed away with soap thoroughly.
- (i) Protect the Module from static, or the CMOS Gate Array IC would be damaged.
- (j) Use finger-stalls with soft gloves in order to keep display clean during the incoming inspection and assembly process.
- (k) Do not disassemble the Module.
- (l) Do not pull or fold the lamp wire.
- (m) Do not adjust the variable resistor located on the Module.
- (n) Protection film for polarizer on the Module should be slowly peeled off just before use so that the electrostatic charge can be minimized.
- (o) Pins of I/F connector should not be touched directly with bare hands.

8.2 Storage

- (a) Do not leave the Module in high temperature, and high humidity for a long time. It is highly recommended to store the Module with temperature from 0 to 35°C and relative humidity of less than 70%.
- (b) Do not store the TFT-LCD Module in direct sunlight.
- (c) The Module should be stored in a dark place. It is prohibited to apply sunlight or fluorescent light in storing.

8.3 Operation

- (a) Do not connect or disconnect the Module in the "Power On" condition.
- (b) Power supply should always be turned on/off by the item 6.3 "Power on/off sequence"
- (c) Module has high frequency circuits. Sufficient suppression to the electromagnetic interference should be done by system manufacturers. Grounding and shielding methods may be important to minimize the interference.
- (d) The cable between the back light connector and its inverter power supply should be connected directly with a minimized length. A longer cable between the back light and the inverter may cause lower luminance of lamp(CCFT) and may require higher startup voltage(Vs).

8.4 Operation Condition Guide

- (a) The LCD product should be operated under normal conditions. Normal condition is defined as below;
 - Temperature : 20± 15°C
 - Humidity : 65± 20%
 - Display pattern : continually changing pattern (Not stationary)
- (b) If the product will be used in extreme conditions such as high temperature, humidity, display patterns or operation time etc., It is strongly recommended to contact SEC for Application engineering advice. Otherwise, its reliability and function may not be guaranteed. Extreme conditions are commonly found at Airports, Transit Stations, Banks, Stock market, and Controlling systems.

8.5 Others

- (a) Ultra-violet ray filter is necessary for outdoor operation.
- (b) Avoid condensation of water. It may result in improper operation or disconnection of electrode.
- (c) Do not exceed the absolute maximum rating value. (supply voltage variation, input voltage variation, variation in part contents and environmental temperature, and so on)
Otherwise the Module may be damaged.
- (d) If the Module keeps displaying the same pattern for a long period of time, the image may be "sticked" to the screen.
To avoid image sticking, it is recommended to use a screen saver.
- (e) This Module has its circuitry PCB's on the rear side and should be handled carefully in order not to be stressed.
- (f) Please contact SEC in advance when you display the same pattern for a long time.