



SmarterGlass

state-of-the-art display solutions

www.smarterglass.com
978 997 4104
sales@smarterglass.com

TFT COLOR LCD MODULE

NL6448BC33-64E

**26cm (10.4 Type)
VGA**

DATA SHEET

DOD-PP-0163 (1st edition)

**This DATA SHEET is updated document from
PRELIMINARY DATA SHEET DOD-PP-0099(1).**

**All information is subject to change without notice.
Please confirm the sales representative before
starting to design your system.**

INTRODUCTION

The Copyright to this document belongs to NEC LCD Technologies, Ltd. (hereinafter called "NEC"). No part of this document will be used, reproduced or copied without prior written consent of NEC.

NEC does and will not assume any liability for infringement of patents, copyrights or other intellectual property rights of any third party arising out of or in connection with application of the products described herein except for that directly attributable to mechanisms and workmanship thereof. No license, express or implied, is granted under any patent, copyright or other intellectual property right of NEC.

Some electronic parts/components would fail or malfunction at a certain rate. In spite of every effort to enhance reliability of products by NEC, the possibility of failures and malfunction might not be avoided entirely. To prevent the risks of damage to death, human bodily injury or other property arising out thereof or in connection therewith, each customer is required to take sufficient measures in its safety designs and plans including, but not limited to, redundant system, fire-containment and anti-failure.

The products are classified into three quality grades: "**Standard**", "**Special**", and "**Specific**" of the highest grade of a quality assurance program at the choice of a customer. Each quality grade is designed for applications described below. Any customer who intends to use a product for application other than that of Standard quality grade is required to contact an NEC sales representative in advance.

The **Standard** quality grade applies to the products developed, designed and manufactured in accordance with the NEC standard quality assurance program, which are designed for such application as any failure or malfunction of the products (sets) or parts/components incorporated therein a customer uses are, directly or indirectly, free of any damage to death, human bodily injury or other property, like general electronic devices.

Examples: Computers, office automation equipment, communications equipment, test and measurement equipment, audio and visual equipment, home electronic appliances, machine tools, personal electronic equipment, industrial robots, etc.

The **Special** quality grade applies to the products developed, designed and manufactured in accordance with an NEC quality assurance program stricter than the standard one, which are designed for such application as any failure or malfunction of the products (sets) or parts/components incorporated therein a customer uses might directly cause any damage to death, human bodily injury or other property, or such application under more severe condition than that defined in the Standard quality grade without such direct damage.

Examples: Control systems for transportation equipment (automobiles, trains, ships, etc.), traffic control systems, anti-disaster systems, anti-crime systems, medical equipment not specifically designed for life support, safety equipment, etc.

The **Specific** quality grade applies to the products developed, designed and manufactured in accordance with the standards or quality assurance program designated by a customer who requires an extremely higher level of reliability and quality for such products.

Examples: Military systems, aircraft control equipment, aerospace equipment, nuclear reactor control systems, medical equipment/devices/systems for life support, etc.

The quality grade of this product is the "**Standard**" unless otherwise specified in this document.

CONTENTS

INTRODUCTION 2

1. OUTLINE 4

 1.1 STRUCTURE AND PRINCIPLE 4

 1.2 APPLICATION 4

 1.3 FEATURES 4

2. GENERAL SPECIFICATIONS 5

3. BLOCK DIAGRAM 6

4. DETAILED SPECIFICATIONS 7

 4.1 MECHANICAL SPECIFICATIONS 7

 4.2 ABSOLUTE MAXIMUM RATINGS 7

 4.3 ELECTRICAL CHARACTERISTICS 8

 4.3.1 LCD panel signal processing board 8

 4.3.2 Backlight lamp 9

 4.3.3 Power supply voltage ripple 11

 4.3.4 Fuse 11

 4.4 POWER SUPPLY VOLTAGE SEQUENCE 12

 4.4.1 LCD panel signal processing board 12

 4.4.2 Inverter 12

 4.5 CONNECTIONS AND FUNCTIONS FOR INTERFACE PINS 13

 4.5.1 LCD panel signal processing board 13

 4.5.2 Backlight lamp 14

 4.5.3 Positions of plugs and a socket 14

 4.6 DISPLAY COLORS AND INPUT DATA SIGNALS 15

 4.7 DISPLAY POSITIONS 16

 4.8 SCANNING DIRECTIONS 16

 4.9 INPUT SIGNAL TIMINGS 17

 4.9.1 Outline of input signal timings 17

 4.9.2 Timing characteristics 18

 4.9.3 Input signal timing chart 20

 4.10 OPTICS 23

 4.10.1 Optical characteristics 23

 4.10.2 Definition of contrast ratio 24

 4.10.3 Definition of luminance uniformity 24

 4.10.4 Definition of response times 24

 4.10.5 Definition of viewing angles 24

5. RELIABILITY TESTS 25

6. PRECAUTIONS 26

 6.1 MEANING OF CAUTION SIGNS 26

 6.2 CAUTIONS 26

 6.3 ATTENTIONS 26

 6.3.1 Handling of the product 26

 6.3.2 Environment 27

 6.3.3 Characteristics 27

 6.3.4 Other 28

7. OUTLINE DRAWINGS 29

 7.1 FRONT VIEW 29

 7.2 REAR VIEW 30

1. OUTLINE

1.1 STRUCTURE AND PRINCIPLE

Color LCD module NL6448BC33-64E is composed of the amorphous silicon thin film transistor liquid crystal display (a-Si TFT LCD) panel structure with driver LSIs for driving the TFT (Thin Film Transistor) array and a backlight.

The a-Si TFT LCD panel structure is injected liquid crystal material into a narrow gap between the TFT array glass substrate and a color-filter glass substrate.

Color (Red, Green, Blue) data signals from a host system (e.g. signal generator, etc.) are modulated into best form for active matrix system by a signal processing circuit, and sent to the driver LSIs which drive the individual TFT arrays.

The TFT array as an electro-optical switch regulates the amount of transmitted light from the backlight assembly, when it is controlled by data signals. Color images are created by regulating the amount of transmitted light through the TFT array of red, green and blue dots.

1.2 APPLICATION

- For industrial use

1.3 FEATURES

- High luminance
- Wide viewing angle
- High contrast
- 6-bit digital RGB signals
- DE (Data enable) function
- Reversible-scan direction
- Edge light type (without inverter)
- Replaceable lamp for backlight
- Acquisition product for UL60950-1/CSA C22.2 No.60950-1-03 (File number: E170632)
- Compliance with the European RoHS directive (2002/95/EC)



2. GENERAL SPECIFICATIONS

Display area	211.2 (H) × 158.4 (V) mm
Diagonal size of display	26cm (10.4 inches)
Drive system	a-Si TFT active matrix
Display color	262,144 colors
Pixel	640 (H) × 480 (V) pixels
Pixel arrangement	RGB (Red dot, Green dot, Blue dot) vertical stripe
Dot pitch	0.11 (H) × 0.33 (V) mm
Pixel pitch	0.33 (H) × 0.33 (V) mm
Module size	243.0 (W) × 185.1 (H) × 10.5 (D) mm (typ.)
Weight	475g (typ.)
Contrast ratio	600:1 (typ.)
Viewing angle	At the contrast ratio ≥ 10:1 <ul style="list-style-type: none"> • Horizontal: Right side 80° (typ.), Left side 80° (typ.) • Vertical: Up side 80° (typ.), Down side 60° (typ.)
Designed viewing direction	At DPS= Low or Open: Normal scan <ul style="list-style-type: none"> • Viewing direction without image reversal: up side (12 o'clock) • Viewing direction with contrast peak: down side (6 o'clock) • Viewing angle with optimum grayscale ($\gamma=2.2$): normal axis (perpendicular)
Polarizer surface	Antiglare
Polarizer pencil-hardness	3H (min.) [by JIS K5400]
Color gamut	At LCD panel center 40% (typ.) [against NTSC color space]
Response time	Ton+Toff (10%←→90%) 25ms (typ.)
Luminance	At IBL= 5.0mArms / lamp 450cd/m ² (typ.)
Signal system	6-bit digital signals for data of RGB colors, Dot clock (CLK), Data enable (DE), Horizontal synchronous signal (Hsync), Vertical synchronous signal (Vsync)
Power supply voltage	LCD panel signal processing board: 3.3V or 5.0V
Backlight	Edge light type: 2 cold cathode fluorescent lamps (Replaceable part <ul style="list-style-type: none"> • Lamp holder set: Type No. 104LHS47) (Recommended inverter (Option) <ul style="list-style-type: none"> • Inverter: Type No.: 104PW161,104PW191)
Power consumption	At IBL= 5.0mArms / lamp, Checkered flag pattern 6.2W (typ., Power dissipation of the inverter is not included.)

3. BLOCK DIAGRAM

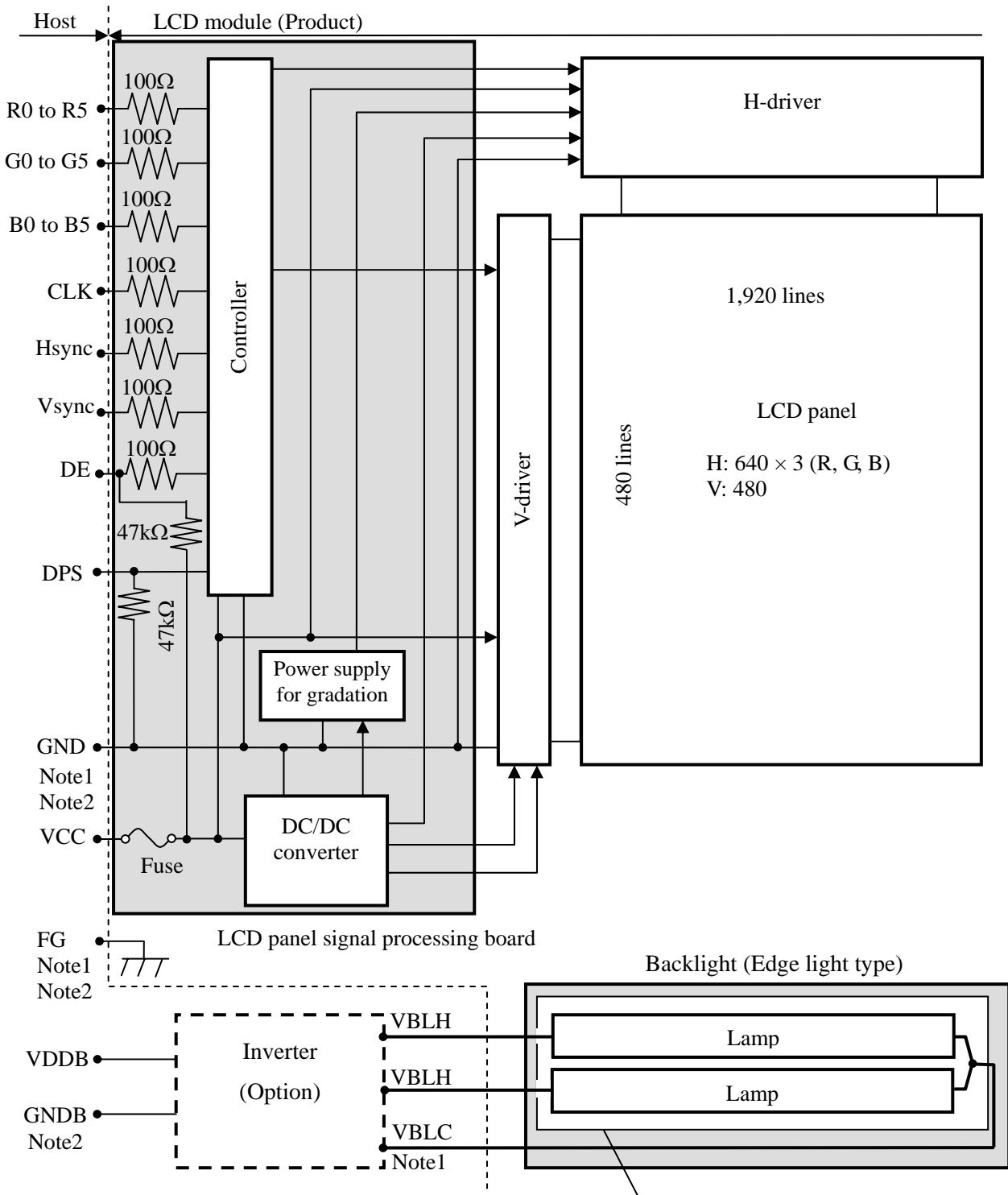

Note1: Relations between GND (Signal ground), FG (Frame ground) and VBLC (Lamp low voltage terminal) in the LCD module are as follows.

GND - FG	Not connected
GND - VBLC	Not connected
FG - VBLC	Not connected

Note2: GND, FG and GNDB must be connected to customer equipment's ground, and it is recommended that these grounds are connected together in customer equipment.

4. DETAILED SPECIFICATIONS

4.1 MECHANICAL SPECIFICATIONS

Parameter	Specification	Unit
Module size	243.0 ± 0.5 (W) × 185.1 ± 0.5 (H) × 10.5 ± 0.5 (D) Note1	mm
Display area	211.2 (H) × 158.4 (V) Note1	mm
Weight	475 (typ.), 500 (max.)	g

Note1: See "7. OUTLINE DRAWINGS".

4.2 ABSOLUTE MAXIMUM RATINGS

Parameter		Symbol	Rating	Unit	Remarks
Power supply voltage	LCD panel signal processing board	VCC	-0.3 to +6.5	V	
	Lamp voltage	VBLH	1,500	Vrms	
Input voltage for signals	Display signals Note1	VD	-0.3 to VCC+0.3	V	-
	Function signal Note2	VF			
Storage temperature		Tst	-20 to +80	°C	-
Operating temperature	Front surface	TopF	-10 to +70	°C	Note3
	Rear surface	TopR	-10 to +70	°C	Note4
Relative humidity Note5	RH		≤ 95	%	Ta ≤ 40°C
			≤ 85	%	40 < Ta ≤ 50°C
			≤ 55	%	50°C < Ta ≤ 60°C
			≤ 36	%	60°C < Ta ≤ 70°C
Absolute humidity Note5		AH	≤ 70 Note6	g/m ³	Ta > 70°C

Note1: CLK, Hsync, Vsync, DE, DATA (R0 to R5, G0 to G5 and B0 to B5)

Note2: DPS

Note3: Measured at center of LCD panel surface (including self-heat)

Note4: Measured at center of LCD module's rear shield surface (including self-heat)

Note5: No condensation

Note6: Water amount at Ta= 70°C and RH= 36%

4.3 ELECTRICAL CHARACTERISTICS

4.3.1 LCD panel signal processing board

(Ta= 25°C)

Parameter		Symbol	min.	typ.	max.	Unit	Remarks
Power supply voltage		VCC	3.0	3.3	3.6	V	at VCC= 3.3V
			4.75	5.0	5.25	V	at VCC= 5.0V
Power supply current		ICC	-	300 Note1	410 Note2	mA	at VCC= 3.3V
			-	200 Note1	270 Note2	mA	at VCC= 5.0V
Logic input voltage for display signals	High	VDH	0.7VCC	-	VCC	V	CMOS level
	Low	VDL	0	-	0.3VCC	V	
Input voltage for DPS signal	High	VFH	0.7VCC	-	VCC	V	
	Low	VFL	0	-	0.3VCC	V	

Note1: Checkered flag pattern [by EIAJ ED-2522]

Note2: Pattern for maximum current

4.3.2 Backlight lamp

(Ta= 25°C, Note1)

Parameter	Symbol	min.	typ.	max.	Unit	Remarks
Lamp current	IBL	2.0	5.0	5.5	mArms	at IBL= 5.0mArms: L= 450cd/m ² Note3, Note4
Lamp voltage	VBLH	-	520	-	Vrms	Note2, Note3
Lamp starting voltage	VS	850	-	-	Vrms	Ta= 25°C Note2, Note3, Note5, Note8
		1,100	-	-	Vrms	Ta= -10°C Note2, Note3, Note5, Note8
Lamp oscillation frequency	FO	50	-	70	kHz	Note6

Note1: This product consists of 2 backlight lamps, and these specifications are for each lamp.

Note2: The lamp voltage cycle between lamps should be kept on a same phase. "VS" and "VBLH" are the voltage value between low voltage side (Cold) and high voltage side (Hot).

Note3: The asymmetric ratio of working waveform for lamps (Power supply voltage peak ratio, power supply current peak ratio and waveform space ratio) should be less than 5 % (See the following figure.). If the waveform is asymmetric, DC (Direct current) element apply into the lamp. In this case, a lamp lifetime may be shortened, because a distribution of a lamp enclosure substance inclines toward one side between low voltage terminal (Cold terminal) and high voltage terminal (Hot terminal). When designing the inverter, evaluate asymmetric of lamp working waveform sufficiently.

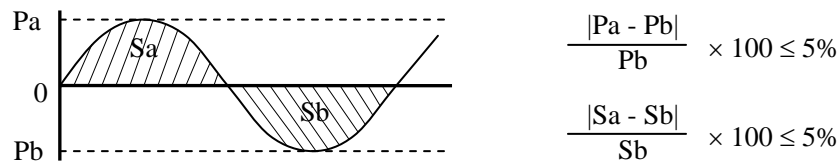

Pa: Supply voltage/current peak for positive, Pb: Supply voltage/current peak for negative
Sa: Waveform space for positive part, Sb: Waveform space for negative part.

Note4: This product consists of 2 lamps. 2 lamps are contained in the 1 lamp holder, and both lamps are connected to 1 low voltage cable. Recommended lamp current is 5.0mArms typical for each lamp, and sum of 2 lamps is 10mArms typical. The lamp current should be measured by high-frequency current meter at the low voltage terminal.

Note5: The inverter should be designed so that the lamp starting voltage can be maintained for more than 1 second. Otherwise the lamp may not be turned on.

Note6: In case "FO" is not the recommended value, beat noise may display on the screen, because of interference between "FO" and "1/th". Recommended value of "FO" is as following.

$$FO = \frac{1}{4} \times \frac{1}{th} \times (2n-1)$$

th: Horizontal cycle (See "4.9.2 Timing characteristics".)

n : Natural number (1, 2, 3)

Note7: Method of lamp cable installation may invite fluctuation of lamp current and voltage or asymmetric of lamp working waveform. When designing method of lamp cable installation, evaluate the fluctuation of lamp current, voltage and working waveform sufficiently.

Note8: In case of Inverter with Ballast condenser, "VS" is the voltage level between Ballast condenser and Connector (Refer to the below "Example of measurement"). "VS" should be designed to be more than minimum "VS". Otherwise the lamp may not be turned on because the lamp starting voltage is less than minimum "VS". ☆

Example of measurement

Probe capacity: 3pF (Tektronix, inc.: P6015A)

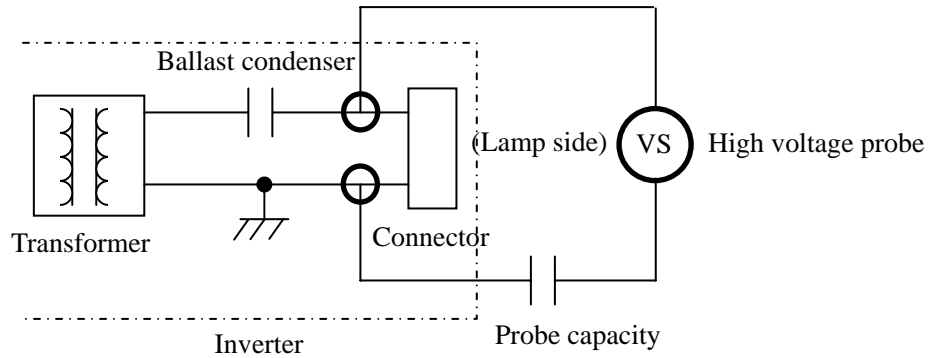

4.3.3 Power supply voltage ripple

This product works, even if the ripple voltage levels are beyond the permissible values as following the table, but there might be noise on the display image.

Power supply voltage		Ripple voltage (Measure at input terminal of power supply)	Note1	Unit
VCC	3.3V		≤ 100	mVp-p
	5.0V		≤ 100	mVp-p

Note1: The permissible ripple voltage includes spike noise.

4.3.4 Fuse

Parameter	Fuse		Rating	Fusing current	Remarks
	Type	Supplier			
VCC	FCC16202AB	KAMAYA ELECTRIC CO., LTD.	2.0A	4.0A	Note1
			32V		

Note1: The power supply capacity should be more than the fusing current. If it is less than the fusing current, the fuse may not blow in a short time, and then nasty smell, smoke and so on may occur.

4.4 POWER SUPPLY VOLTAGE SEQUENCE

4.4.1 LCD panel signal processing board

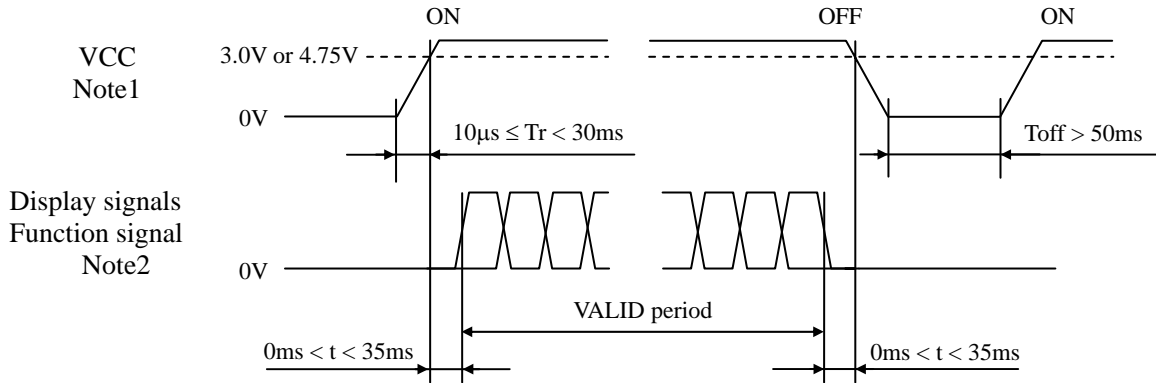

Note1: In terms of voltage variation (voltage drop) while VCC rising edge is below 3.0V in "VCC = 3.3V" or 4.75V in "VCC = 5.0V", a protection circuit may work, and then this product may not work.

Note2: Display signals (CLK, Hsync, Vsync, DE, DATA (R0 to R5, G0 to G5, B0 to B5)) and function signal (DPS) must be Low or High-impedance, exclude the VALID period (See above sequence diagram), in order to avoid that internal circuits is damaged.

If some of display and function signals of this product are cut while this product is working, even if the signal input to it once again, it might not work normally. VCC should be cut when the display and function signals are stopped.

4.4.2 Inverter (Option)

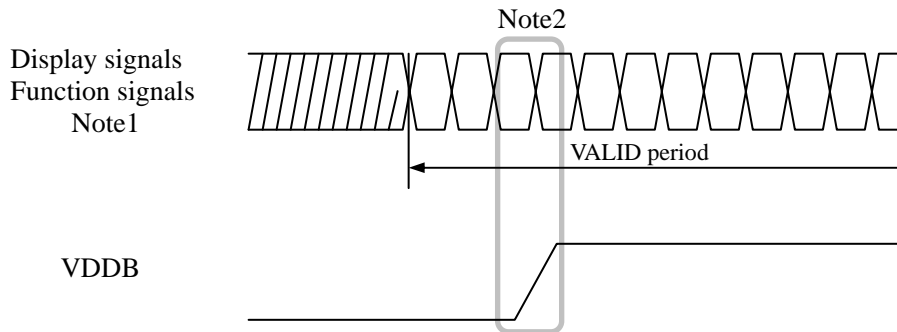

Note1: These are the display and function signals for LCD panel signal processing board.

Note2: The backlight should be turned on within the valid period of display and function signals, in order to avoid unstable data display.

4.5 CONNECTIONS AND FUNCTIONS FOR INTERFACE PINS

4.5.1 LCD panel signal processing board

CN1 socket (LCD module side): DF9C-31P-1V (2*) (Hirose Electric Co., Ltd. (HRS))

Adaptable plug: DF9-31S-1V (2*), DF9-31S-1V (3*) (Hirose Electric Co., Ltd. (HRS))

Pin No.	Symbol	Signal	Remarks
1	GND	Ground	Note1
2	CLK	Dot clock	-
3	Hsync	Horizontal synchronous signal	
4	Vsync	Vertical synchronous signal	
5	GND	Ground	
6	R0	Red data (LSB)	Least significant bit
7	R1	Red data	-
8	R2	Red data	
9	R3	Red data	
10	R4	Red data	
11	R5	Red data (MSB)	Most significant bit
12	GND	Ground	Note1
13	G0	Green data (LSB)	Least significant bit
14	G1	Green data	-
15	G2	Green data	
16	G3	Green data	
17	G4	Green data	
18	G5	Green data (MSB)	Most significant bit
19	GND	Ground	Note1
20	B0	Blue data (LSB)	Least significant bit
21	B1	Blue data	-
22	B2	Blue data	
23	B3	Blue data	
24	B4	Blue data	
25	B5	Blue data (MSB)	Most significant bit
26	GND	Ground	Note1
27	DE	Selection of DE / Fixed mode	Data enable signal: DE mode High or Open: Fixed mode
28	VCC	Power supply	Note1
29	VCC	Power supply	
30	N.C.	-	Keep this pin Open.
31	DPS	Selection of scan direction	High: Reverse scan Low or Open: Normal scan Note2

Note1: All GND and VCC terminals should be used without any non-connected lines.

Note2: See "4.8 SCANNING DIRECTIONS".

4.5.2 Backlight lamp

Attention: VBLH and VBLC must be connected correctly. Wrong connections will cause electric shock and also break down of the product.

CN2 plug (LCD module side): BHR-03VS-1 (J.S.T Mfg. Co., Ltd.)
 Adaptable socket: SM03 (4.0) B-BHS-1-TB (LF)(SN),
 SM03 (4.0) B-BHS-1-TB (J.S.T Mfg. Co., Ltd.)

Pin No.	Symbol	Signal	Remarks
1	VBLC	Low voltage (Cold)	Cable color: Black
2	VBLH	High voltage (Hot)	Cable color: White
3	VBLH	High voltage (Hot)	Cable color: White

4.5.3 Positions of plugs and a socket

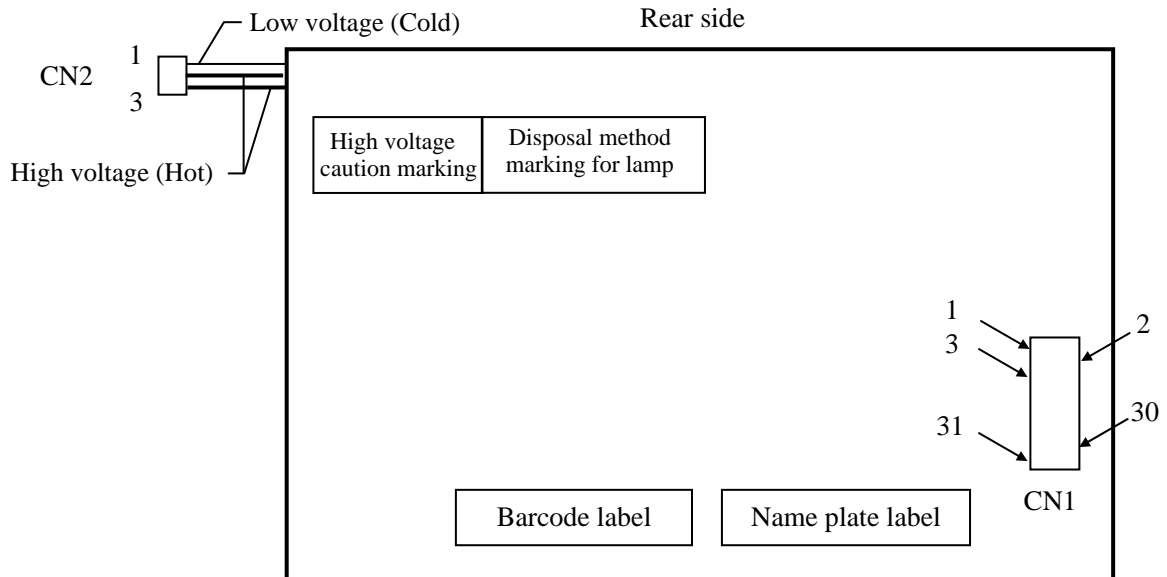

4.6 DISPLAY COLORS AND INPUT DATA SIGNALS

This product can display in equivalent to 262,144 colors in 64 gray scales. Also the relation between display colors and input data signals is as the following table.

Display colors		Data signal (0: Low level, 1: High level)																	
		R5	R4	R3	R2	R1	R0	G5	G4	G3	G2	G1	G0	B5	B4	B3	B2	B1	B0
Basic colors	Black	0	0	0	0	0	0	0	0	0	0	0	0	0	0	0	0	0	0
	Blue	0	0	0	0	0	0	0	0	0	0	0	0	1	1	1	1	1	1
	Red	1	1	1	1	1	1	0	0	0	0	0	0	0	0	0	0	0	0
	Magenta	1	1	1	1	1	1	0	0	0	0	0	0	1	1	1	1	1	1
	Green	0	0	0	0	0	0	1	1	1	1	1	1	0	0	0	0	0	0
	Cyan	0	0	0	0	0	0	1	1	1	1	1	1	1	1	1	1	1	1
	Yellow	1	1	1	1	1	1	1	1	1	1	1	1	0	0	0	0	0	0
	White	1	1	1	1	1	1	1	1	1	1	1	1	1	1	1	1	1	1
Red gray scale	Black	0	0	0	0	0	0	0	0	0	0	0	0	0	0	0	0	0	0
		0	0	0	0	0	0	0	0	0	0	0	0	0	0	0	0	0	0
	dark	0	0	0	0	1	0	0	0	0	0	0	0	0	0	0	0	0	0
	↑				:														
	↓				:														
bright	1	1	1	1	0	1	0	0	0	0	0	0	0	0	0	0	0	0	
Red	1	1	1	1	1	1	0	0	0	0	0	0	0	0	0	0	0	0	
Green gray scale	Black	0	0	0	0	0	0	0	0	0	0	0	0	0	0	0	0	0	0
		0	0	0	0	0	0	0	0	0	0	0	1	0	0	0	0	0	0
	dark	0	0	0	0	0	0	0	0	0	0	1	0	0	0	0	0	0	0
	↑				:														
	↓				:														
bright	0	0	0	0	0	0	1	1	1	1	0	1	0	0	0	0	0	0	
Green	0	0	0	0	0	0	1	1	1	1	1	1	0	0	0	0	0	0	
Blue gray scale	Black	0	0	0	0	0	0	0	0	0	0	0	0	0	0	0	0	0	0
		0	0	0	0	0	0	0	0	0	0	0	0	0	0	0	0	0	1
	dark	0	0	0	0	0	0	0	0	0	0	0	0	0	0	0	0	1	0
	↑				:														
	↓				:														
bright	0	0	0	0	0	0	0	0	0	0	0	0	1	1	1	1	0	1	
Blue	0	0	0	0	0	0	0	0	0	0	0	0	1	1	1	1	1	0	
	0	0	0	0	0	0	0	0	0	0	0	0	1	1	1	1	1	1	

4.7 DISPLAY POSITIONS

The following table is the coordinates per pixel (See "4.8 SCANNING DIRECTIONS".).

C (0, 0)						
R	G	B				
C(0, 0)	C(1, 0)	• • •	C(X, 0)	• • •	C(638, 0)	C(639, 0)
C(0, 1)	C(1, 1)	• • •	C(X, 1)	• • •	C(638, 1)	C(639, 1)
•	•	•	•	•	•	•
•	•	• • •	•	• • •	•	• • •
•	•	•	•	•	•	•
C(0, Y)	C(1, Y)	• • •	C(X, Y)	• • •	C(638, Y)	C(639, Y)
•	•	•	•	•	•	•
•	•	• • •	•	• • •	•	• • •
•	•	•	•	•	•	•
C(0, 478)	C(1, 478)	• • •	C(X, 478)	• • •	C(638, 478)	C(639, 478)
C(0, 479)	C(1, 479)	• • •	C(X, 479)	• • •	C(638, 479)	C(639, 479)

4.8 SCANNING DIRECTIONS

The following figures are seen from a front view. Also the arrow shows the direction of scan.

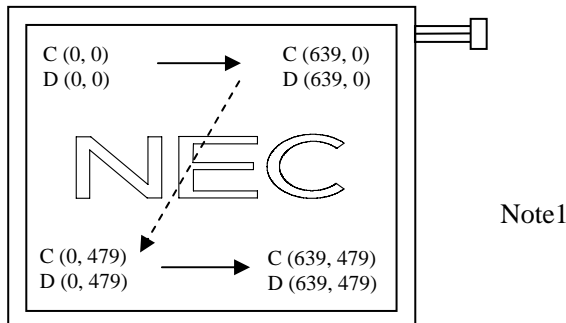

Figure 1. Normal scan (DPS: Low or Open)

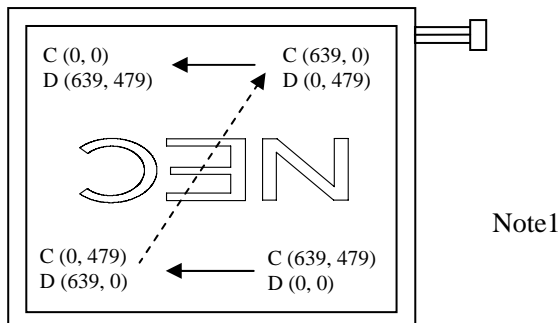

Figure 2. Reverse scan (DPS: High)

Note1: Meaning of C (X, Y) and D (X, Y)

C (X, Y): The coordinates of the display position (See "4.7 DISPLAY POSITIONS".)

D (X, Y): The data number of input signal for LCD panel signal processing board

4.9 INPUT SIGNAL TIMINGS

4.9.1 Outline of input signal timings

• Horizontal signal

Note1

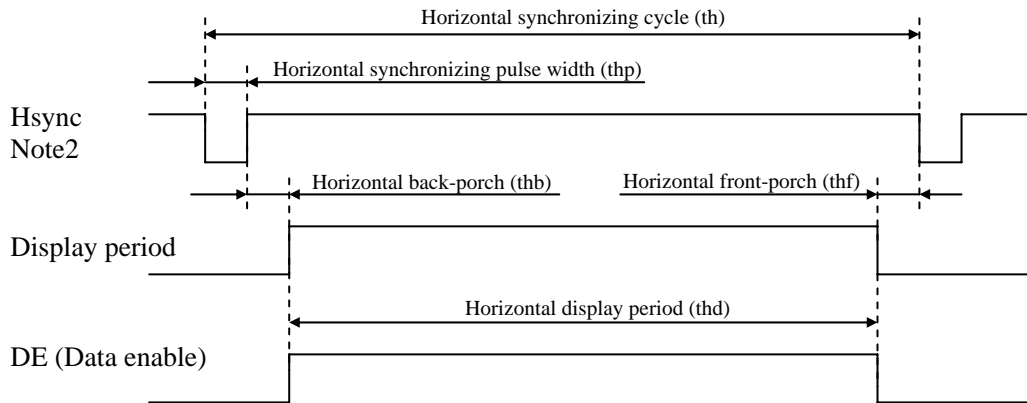

• Vertical signal

Note1

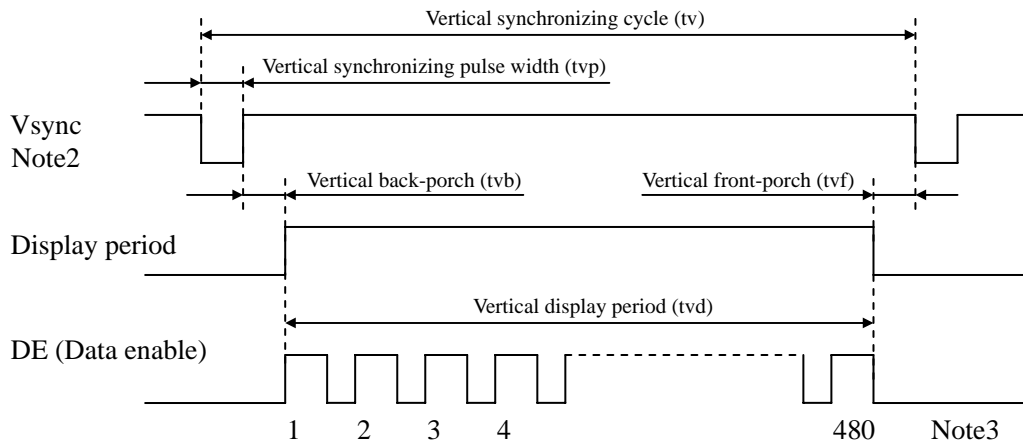

Note1: This diagram indicates virtual signal for set up to timing.

Note2: Fixed mode cannot be used while working of DE mode.

Note3: See "4.9.3 Input signal timing chart" for numeration of pulse.

4.9.2 Timing characteristics

(a) Fixed mode

(Note1)

Parameter		Symbol	min.	typ.	max.	Unit	Remarks		
CLK	Frequency	1/tc	21.0	25.175	29.0	MHz	39.72ns (typ.)		
	Duty	tcd	0.4	0.5	0.6	-	-		
	Rise time, Fall time	trf	-	-	10	ns			
DATA (R0-R5) (G0-G5) (B0-B5)	CLK-DATA	Setup time	tds	3	-	-	ns	-	
		Hold time	tdh	5	-	-	ns		
	Rise time, Fall time	tdrf	-	-	10	ns			
Hsync	Cycle	th	30.0	31.778	33.6	μs	31.468kHz (typ.)		
			800			CLK	-		
	Display period	thd	640			CLK			
	Front-porch	thf	16			CLK			
	Pulse width	thp	10	96	-	CLK			
	Back-porch	thb	-	48	134	CLK			
	Total of pulse width and back-porch	thp + thb	144			CLK		Note2	
	CLK- Hsync	Setup time	ths	3	-	-		ns	-
		Hold time	thh	5	-	-		ns	
Rise time, Fall time	thrf	-	-	10	ns				
Vsync	Cycle	tv	16.1	16.683	17.2	ms	59.94Hz (typ.)		
			525			H	-		
	Display period	tvd	480			H			
	Front-porch	tvf	12			H			
	Pulse width	tvp	1	2	-	H			
	Back-porch	tvb	-	31	32	H			
	Total of pulse width and back-porch	tvp + tvb	33			H		Note2	
	Hsync-Vsync	Setup time	tvhs	3	-	-		ns	-
		Hold time	tvhh	5	-	-		ns	
Rise time, Fall time	tvrf	-	-	10	ns				

Note1: Definition of parameters is as follows.

tc= 1CLK, tcd= tch/tc, th= 1H

Note2: Keep tvp + tvb and thp + thb within the table. If it is out of specification, display position will be shifted to right/left side or up/down.

(b) DE mode

(Note1, Note2, Note3)

Parameter		Symbol	min.	typ.	max.	Unit	Remarks	
CLK	Frequency	1/tc	21.0	25.175	29.0	MHz	39.72ns (typ.)	
	Duty	tcd	0.4	0.5	0.6	-	-	
	Rise time, Fall time	trf	-	-	10	ns		
DATA (R0-R5) (G0-G5) (B0-B5)	CLK-DATA	Setup time	tds	3	-	-	ns	-
		Hold time	tdh	5	-	-	ns	
	Rise time, Fall time	tdrf	-	-	10	ns		
DE	Horizontal	Cycle	th	30.0	31.778	33.6	μs	31.468kHz (typ.)
				-	800	-	CLK	-
	Vertical (One frame)	Cycle	tv	16.1	16.683	17.2	ms	59.94Hz (typ.)
				-	525	-	H	-
	CLK-DE	Setup time	tdes	3	-	-	ns	
				Hold time	tdeh	5	-	
	Rise time, Fall time		tderf			-	-	
	Display period		thd	640			CLK	
Display period		tvd	480			H	-	

Note1: Definition of parameters is as follows.

tc= 1CLK, tcd= tch/tc, th= 1H

Note2: Hsync signal (CN1-Pin No.3) and Vsync signal (CN1-Pin No.4) are not used inside the product at DE mode, but do not keep these pins open to avoid noise problem.

Note3: Vertical cycle (tv) should be specified in integral multiple of Horizontal cycle (th).

4.9.3 Input signal timing chart

(a) Fixed mode

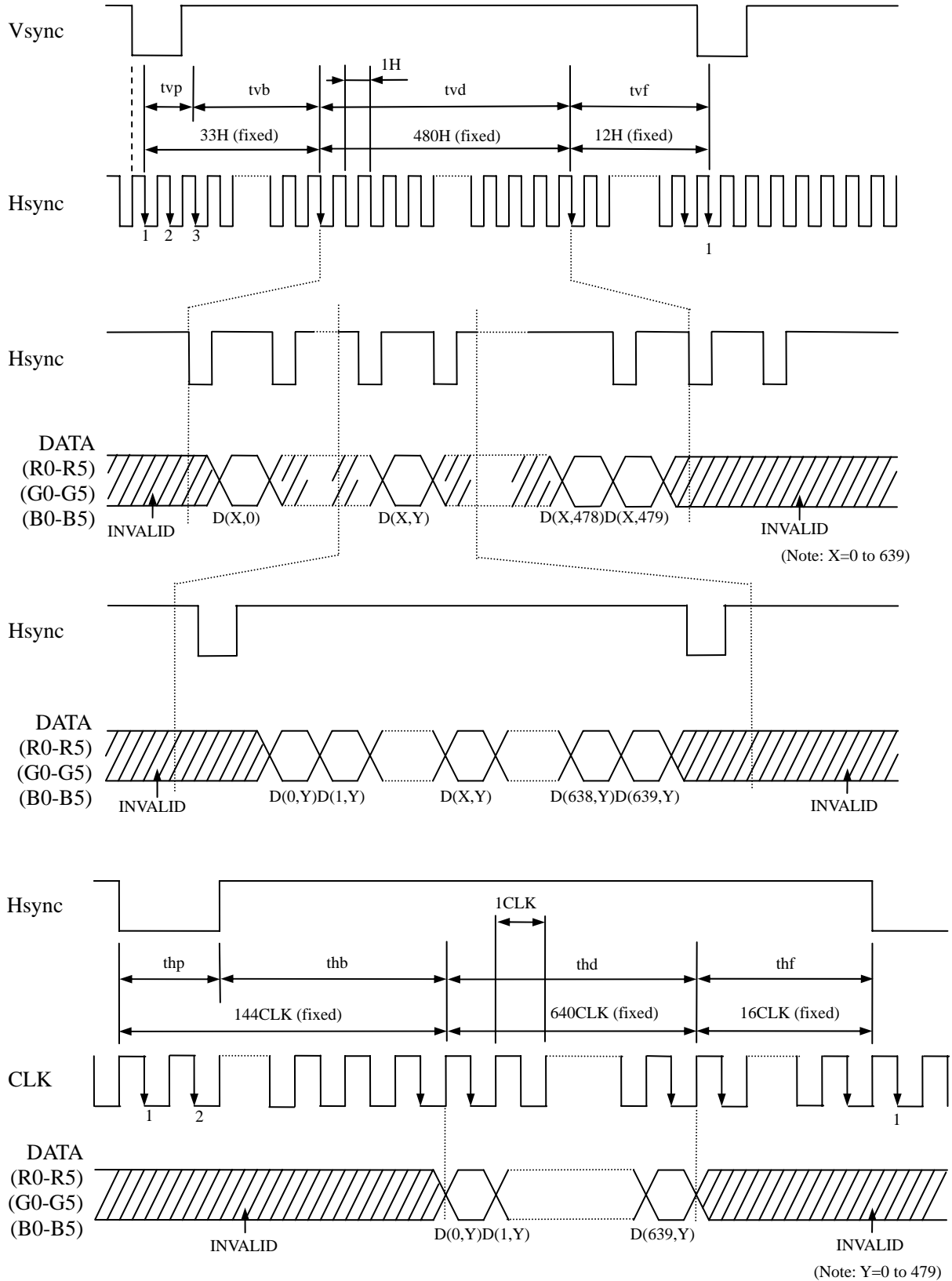

(b) DE mode

Horizontal timing

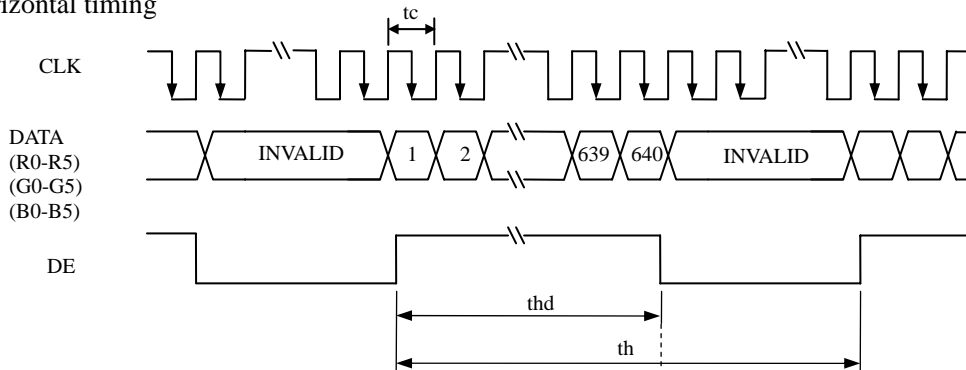

Vertical timing

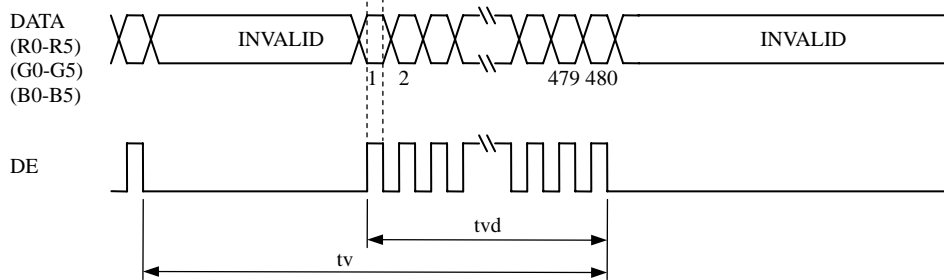

(c) Common item of Fixed mode and DE mode

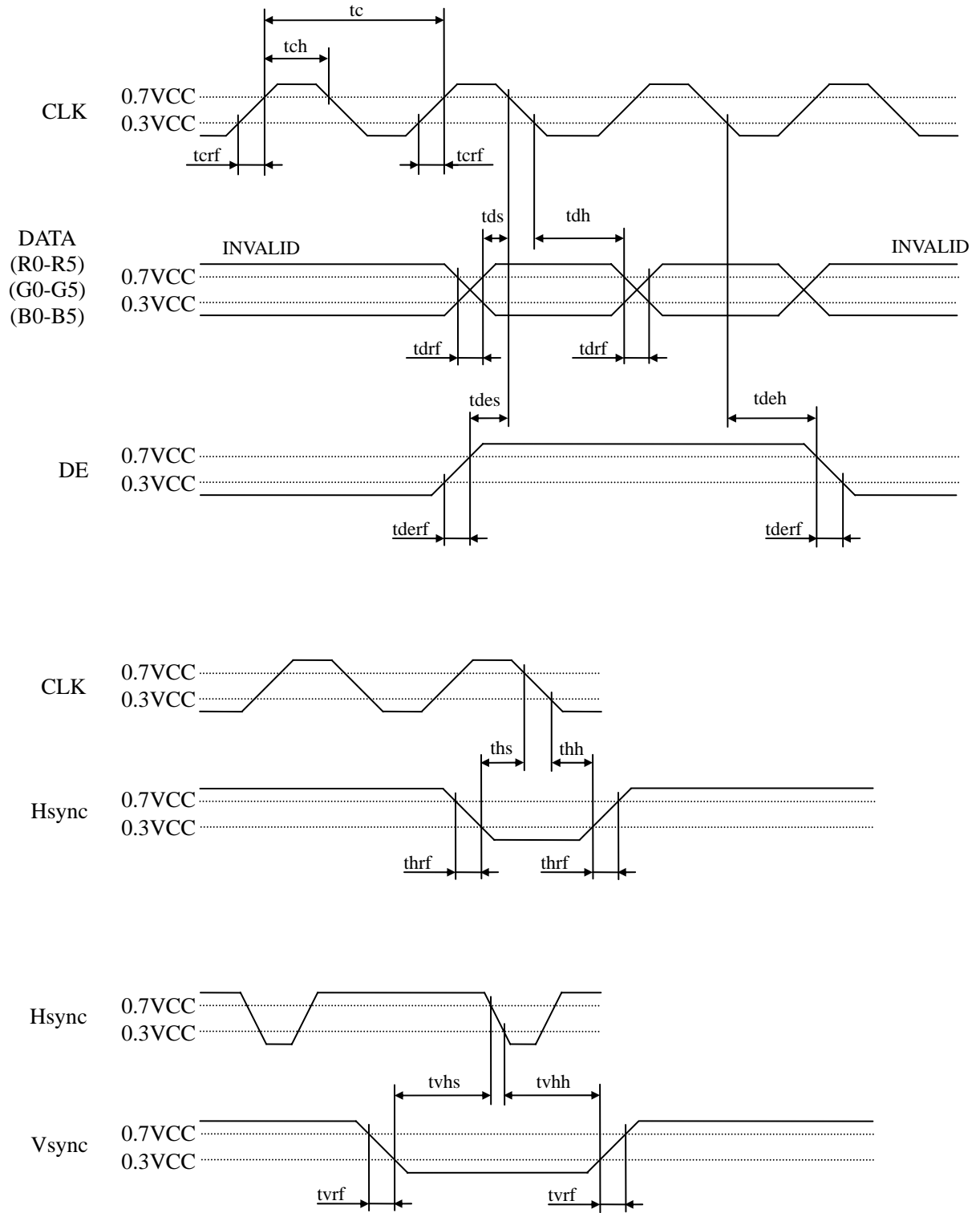

4.10 OPTICS

4.10.1 Optical characteristics

(Note1, Note2)

Parameter	Condition	Symbol	min.	typ.	max.	Unit	Measuring instrument	Remarks	
Luminance	White at center $\theta R=0^\circ, \theta L=0^\circ, \theta U=0^\circ, \theta D=0^\circ$	L	350	450	-	cd/m ²	BM-5A	-	
Contrast ratio	White/Black at center $\theta R=0^\circ, \theta L=0^\circ, \theta U=0^\circ, \theta D=0^\circ$	CR	300	600	-	-	BM-5A	Note3	
Luminance uniformity	White $\theta R=0^\circ, \theta L=0^\circ, \theta U=0^\circ, \theta D=0^\circ$	LU	-	1.25	1.4	-	BM-5A	Note4	
Chromaticity	White	x coordinate	Wx	0.283	0.313	0.343	-	SR-3	Note5
		y coordinate	Wy	0.299	0.329	0.359	-		
	Red	x coordinate	Rx	-	0.590	-	-		
		y coordinate	Ry	-	0.341	-	-		
	Green	x coordinate	Gx	-	0.325	-	-		
		y coordinate	Gy	-	0.528	-	-		
Blue	x coordinate	Bx	-	0.159	-	-			
	y coordinate	By	-	0.157	-	-			
Color gamut	$\theta R=0^\circ, \theta L=0^\circ, \theta U=0^\circ, \theta D=0^\circ$ at center, against NTSC color space	C	35	40	-	%			
Response time	White to Black	Ton	-	6	15	ms	BM-5A	Note6	
	Black to White	Toff	-	19	47	ms		Note7	
Viewing angle	Right	$\theta U=0^\circ, \theta D=0^\circ, CR \geq 10$	θR	70	80	-	EZ Contrast	Note8	
	Left	$\theta U=0^\circ, \theta D=0^\circ, CR \geq 10$	θL	70	80	-			
	Up	$\theta R=0^\circ, \theta L=0^\circ, CR \geq 10$	θU	70	80	-			
	Down	$\theta R=0^\circ, \theta L=0^\circ, CR \geq 10$	θD	50	60	-			

Note1: These are initial characteristics.

Note2: Measurement conditions are as follows.

Ta= 25°C, VCC= 3.3V, IBL= 5.0mA rms/lamp, Display mode: VGA, Horizontal cycle= 1/31.468kHz, Vertical cycle= 1/59.94Hz, DPS= Low or Open: Normal scan

Optical characteristics are measured at luminance saturation after 20minutes from working the product, in the dark room. Also measurement methods are as follows.

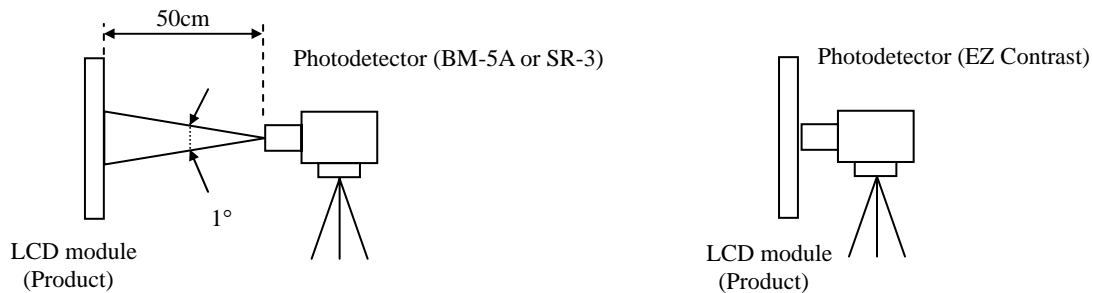

Note3: See "4.10.2 Definition of contrast ratio".

Note4: See "4.10.3 Definition of luminance uniformity".

Note5: These coordinates are found on CIE 1931 chromaticity diagram.

Note6: Product surface temperature: TopF= 30°C

Note7: See "4.10.4 Definition of response times".

Note8: See "4.10.5 Definition of viewing angles".

4.10.2 Definition of contrast ratio

The contrast ratio is calculated by using the following formula.

$$\text{Contrast ratio (CR)} = \frac{\text{Luminance of white screen}}{\text{Luminance of black screen}}$$

4.10.3 Definition of luminance uniformity

The luminance uniformity is calculated by using following formula.

$$\text{Luminance uniformity (LU)} = \frac{\text{Maximum luminance from ① to ⑤}}{\text{Minimum luminance from ① to ⑤}}$$

The luminance is measured at near the 5 points shown below.

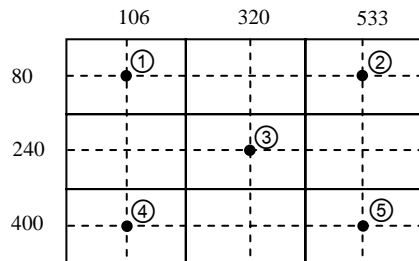

4.10.4 Definition of response times

Response time is measured, the luminance changes from "white" to "black", or "black" to "white" on the same screen point, by photo-detector. Ton is the time it takes the luminance change from 90% down to 10%. Also Toff is the time it takes the luminance change from 10% up to 90% (See the following diagram.).

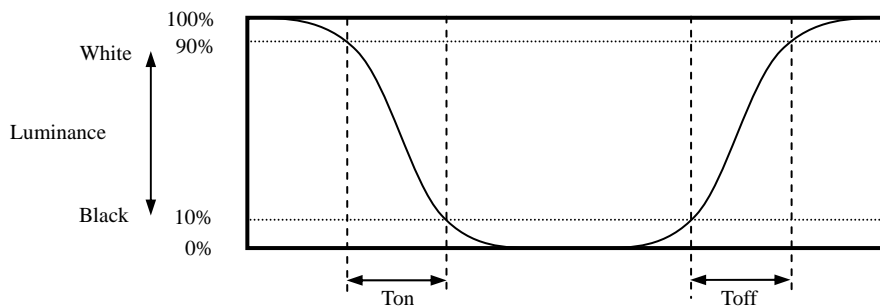

4.10.5 Definition of viewing angles

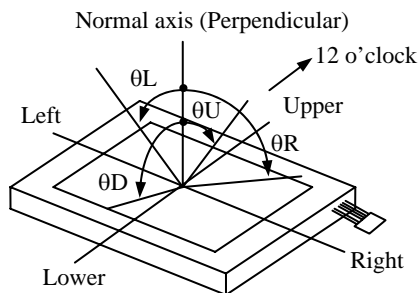

5. RELIABILITY TESTS

Test item	Condition	Judgment
High temperature and humidity (Operation)	① 60 ± 2°C, RH= 90%, 240hours ② Display data is black.	No display malfunctions Note1
High temperature (Operation)	① 70 ± 3°C, 240hours ② Display data is black.	
Heat cycle (Operation)	① -10 ± 3°C...1hour 70 ± 3°C...1hour ② 50cycles, 4 hours/cycle ③ Display data is black.	
Thermal shock (Non operation)	① -20 ± 3°C...30minutes 80 ± 3°C...30minutes ② 100cycles, 1hour/cycle ③ Temperature transition time is within 5 minutes.	
ESD (Operation)	① 150pF, 150Ω, ±10kV ② 9 places on a panel surface Note2 ③ 10 times each places at 1 sec interval	
Dust (Operation)	① Sample dust: No. 15 (by JIS-Z8901)) ② 15 seconds stir ③ 8 times repeat at 1 hour interval	
Vibration (Non operation)	① 5 to 100Hz, 19.6m/s ² ② 1 minute/cycle ③ X, Y, Z direction ④ 120 times each directions	No display malfunctions No physical damages Note1
Mechanical shock (Non operation)	① 539m/ s ² , 11ms ② ±X, ±Y, ±Z direction ③ 5 times each directions	

Note1: Display and appearance are checked under environmental conditions equivalent to the inspection conditions of defect criteria.

Note2: See the following figure for discharge points.

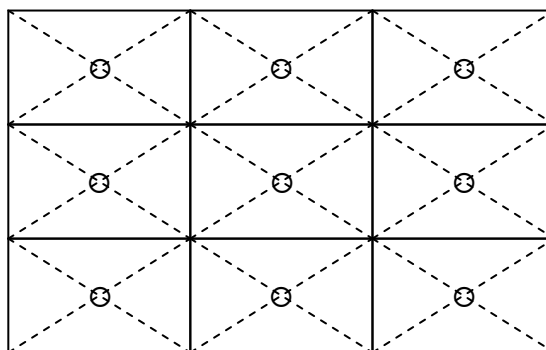



6. PRECAUTIONS

6.1 MEANING OF CAUTION SIGNS

The following caution signs have very important meaning. **Be sure to read "6.2 CAUTIONS" and "6.3 ATTENTIONS", after understanding these contents!**

	This sign has the meaning that customer will be injured by himself or the product will sustain a damage, if customer has wrong operations.
---	--

	This sign has the meaning that customer will get an electrical shock, if customer has wrong operations.
---	---

	This sign has the meaning that customer will be injured by himself, if customer has wrong operations.
---	---

6.2 CAUTIONS

	* Do not touch the working backlight. There is a danger of an electric shock.
---	--

	<p>* Do not touch the working backlight. There is a danger of burn injury.</p> <p>* Do not shock and press the LCD panel and the backlight! There is a danger of breaking, because they are made of glass. (Shock: To be not greater 539m/s² and to be not greater 11ms, Pressure: To be not greater 19.6 N (φ16mm jig))</p>
---	---

6.3 ATTENTIONS 

6.3.1 Handling of the product

- ① Take hold of both ends without touching the circuit board when the product (LCD module) is picked up from inner packing box to avoid broken down or misadjustment, because of stress to mounting parts on the circuit board.
- ② Do not hook nor pull cables such as lamp cable, and so on, in order to avoid any damage.
- ③ When the product is put on the table temporarily, display surface must be placed downward.
- ④ When handling the product, take the measures of electrostatic discharge with such as earth band, ionic shower and so on, because the product may be damaged by electrostatic.
- ⑤ The torque for product mounting screws must never exceed 0.294N·m. Higher torque might result in distortion of the bezel.
- ⑥ The product must be installed using mounting holes without undue stress such as bends or twist (See outline drawings). And do not add undue stress to any portion (such as bezel flat area). Bends or twist described above and undue stress to any portion may cause display mura.
- ⑦ Do not press or rub on the sensitive product surface. When cleaning the product surface, use of the cloth with ethanolic liquid such as screen cleaner for LCD is recommended.
- ⑧ Do not push nor pull the interface connectors while the product is working.
- ⑨ Do not bend or unbend the lamp cable at the near part of the lamp holding rubber, to avoid the damage for high voltage side of the lamp.

- ⑩ Properly connect the plug (backlight side) to adaptable socket (inverter side) without incomplete connection. After connecting, be careful not to hook the lamp cables because incomplete connection may occur by hooking the lamp cables. This incomplete connection may cause abnormal operation of high voltage circuit.
- ⑪ If the lamp cable is attached on the metal part of the product directly, high frequency leak current to the metal part may occur, then the brightness may decrease or the lamp may not be turned on.
- ⑫ When not connecting FG of the LCD module to the customer's equipment ground, inverter noise may create video noise on the LCD screen.
- ⑬ When handling the product, use of an original protection sheet on the product surface (polarizer) is recommended for protection of product surface. Adhesive type protection sheet may change color or characteristics of the polarizer.
- ⑭ Usually liquid crystals don't leak through the breakage of glasses because of the surface tension of thin layer and the construction of LCD panel. But, if you contact with liquid crystal for the worst, please wash it out with soap. ☆

6.3.2 Environment

- ① Do not operate or store in high temperature, high humidity, dewdrop atmosphere or corrosive gases. Keep the product in packing box with antistatic pouch in room temperature to avoid dusts and sunlight, when storing the product.
- ② In order to prevent dew condensation occurring by temperature difference, the product packing box should be opened after enough time being left under the environment of an unpacking room. Evaluate the leaving time sufficiently because a situation of dew condensation occurring is changed by the environmental temperature and humidity. (Recommended leaving time: 6 hours or more with packing state)
- ③ Do not operate in high magnetic field. Circuit boards may be broken down by it.
- ④ This product is not designed as radiation hardened.

6.3.3 Characteristics

The following items are neither defects nor failures.

- ① Response time, luminance and color may be changed by ambient temperature.
- ② Display mura, flicker, vertical seam or small spot may be observed depending on display patterns.
- ③ Optical characteristics (e.g. luminance, display uniformity, etc.) gradually is going to change depending on operating time, and especially low temperature, because the LCD has cold cathode fluorescent lamps.
- ④ Do not display the fixed pattern for a long time because it may cause image sticking. Use a screen saver, if the fixed pattern is displayed on the screen.
- ⑤ The display color may be changed depending on viewing angle because of the use of condenser sheet in the backlight.
- ⑥ Optical characteristics may be changed depending on input signal timings.
- ⑦ The interference noise between input signal frequency for this product's signal processing board and luminance control frequency of the inverter may appear on a display. Set up luminance control frequency of the inverter so that the interference noise does not appear.
- ⑧ After the product is stored under condition of low temperature or dark place for a long time, the cold cathode fluorescent lamp may not be turned on under the same condition because of the general characteristic of cold cathode fluorescent lamp. In addition, when Luminance control ratio is low in pulse width modulation method inverter, the lamp may not be turned on. In this case, power should be supplied again. ☆

6.3.4 Other

- ① All GND and VCC terminals should be used without any non-connected lines.
- ② Do not disassemble a product or adjust variable resistors.
- ③ See "REPLACEMENT MANUAL FOR LAMP HOLDER SET", when replacing backlight lamps.
- ④ Pay attention not to insert foreign materials inside of the product, when using tapping screws.
- ⑤ Pack the product with original shipping package, in order to avoid any damages during transportation, when returning the product to NEC for repair and so on.

7. OUTLINE DRAWINGS

7.1 FRONT VIEW

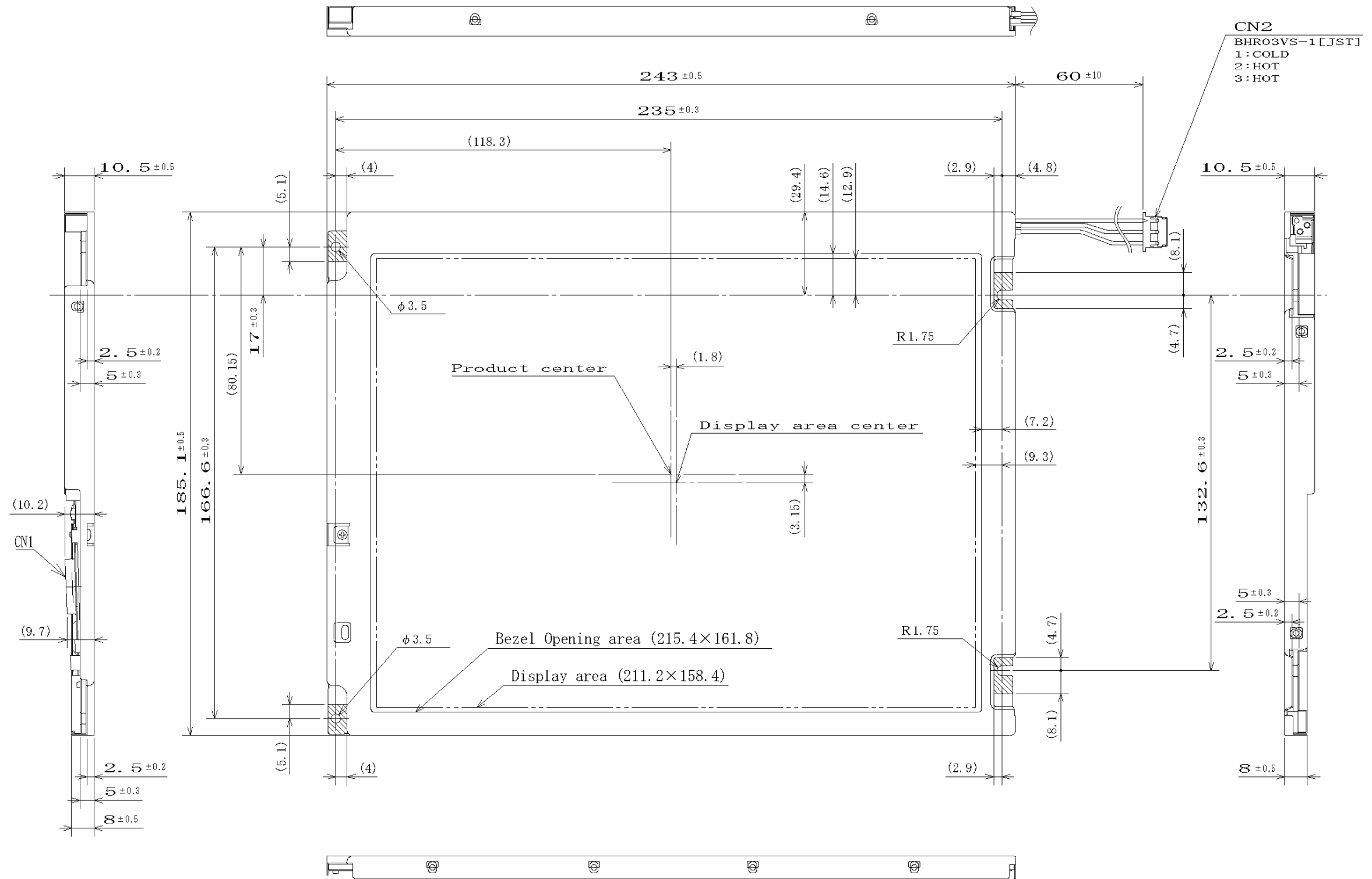

Note1: The values in parentheses are for reference.

Note3: The torque for product mounting screws must never exceed 0.294N·m.

Note3:  Mounting hole portions (4 pieces)

Unit: mm

7.2 REAR VIEW

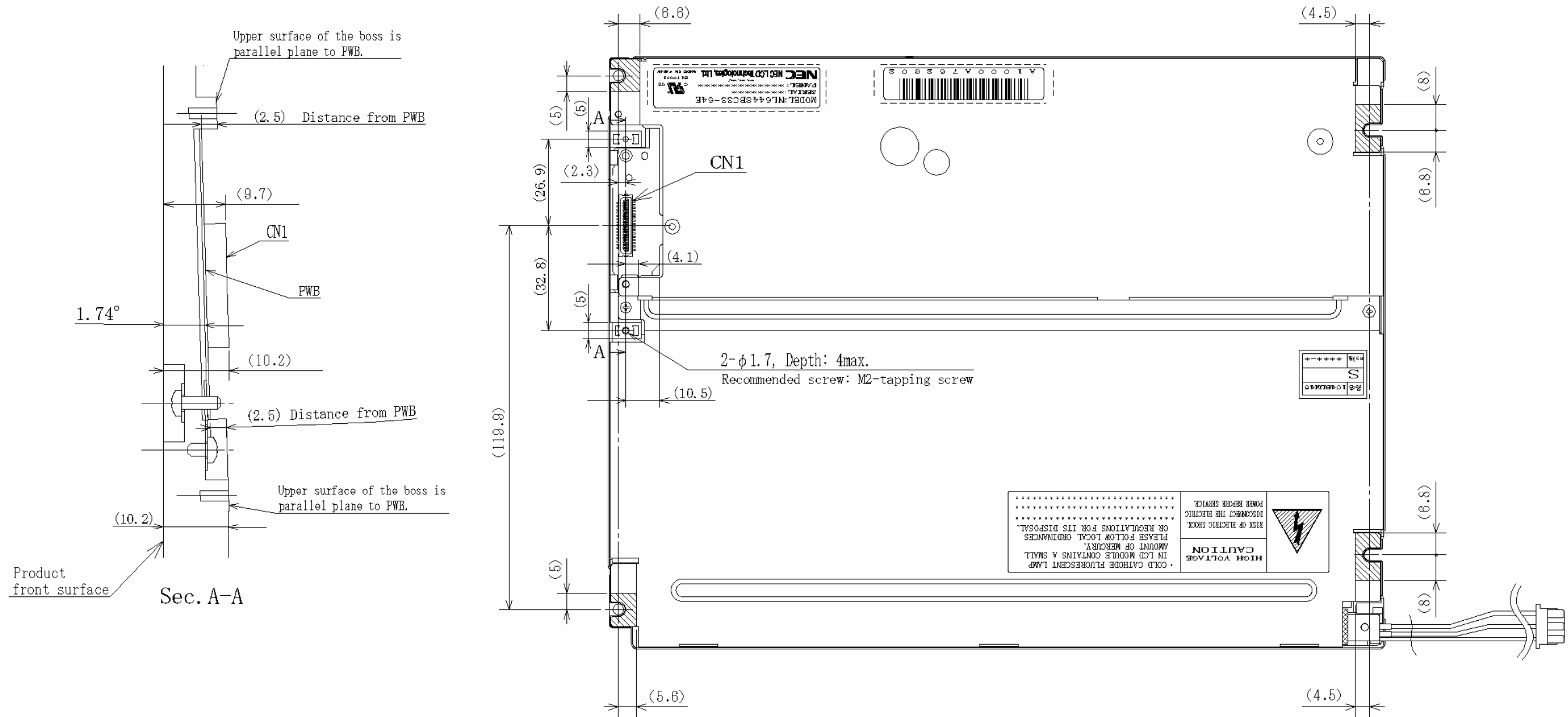

Note1: The values in parentheses are for reference.
 Note3: The torque for product mounting screws must never exceed 0.294N·m.
 Note3:  Mounting hole portions (4 pieces)

Unit: mm