



SmarterGlass

state-of-the-art display solutions

www.smarterglass.com
978 997 4104
sales@smarterglass.com



Product Description: TFT-LCD PANEL			

AUO Model Name: T370XW02 V5			
Customer Part No/Project Name:			
Customer Signature	Date	AUO	Date
		Approved By: PM Sr. Manager/YuChieh.Lin	
		Reviewed By: RD Director/Hong Hong Jye	
		Reviewed By: Project leader/Jerry Hsu	
		Prepared By: PM/Eric Chiang	



Document Version: 0.0

Date: 2007/02/13

Product Specifications

37.0" WXGA Color TFT-LCD Module

Model Name: T370XW02

V.5

() Preliminary Specifications

(*) Final Specifications

Note: This Specification is subject to change without notice.



Contents

No	ITEM
	COVER
	CONTENTS
	RECORD OF REVISIONS
1	GENERAL DESCRIPTION
2	ABSOLUTE MAXIMUM RATINGS
3	ELECTRICAL SPECIFICATIONS
3-1	ELECTRICAL CHARACTERISTICS
3-2	INTERFACE CONNECTIONS
3-3	INPUT TIMING SPECIFICATIONS
3-4	SIGNAL TIMING WAVEFORMS
3-5	COLOR INPUT DATA REFERENCE
3-6	POWER SEQUENCE
4	OPTICAL SPECIFICATIONS
5	MECHANICAL CHARACTERISTICS
6	RELIABILITY
7	INTERNATIONAL STANDARDS
7-1	SAFETY
7-2	EMC
7-3	GREEN
8	Packing
9	PRECAUTIONS



1. General Description

This specification applies to the 37.0 inch Color TFT-LCD Module T370XW02 V5. This LCD module has a TFT active matrix type liquid crystal panel 1366x768 pixels, and diagonal size of 37.0 inch. This module supports 1366x768 XGA-Wide mode (Non-interlace).

Each pixel is divided into Red, Green and Blue sub-pixels or dots which are arranged in vertical stripes. Gray scale or the brightness of the sub-pixel color is determined with an 8-bit gray scale signal for each dot.

The T370XW02 V5 has been designed to apply the 8-bit 1 channel LVDS interface operation. It is intended to support displays where high brightness, wide viewing angle, high color saturation, and high color depth are very important.

* General Information

Items	Specification	Unit	Note
Active Screen Size	37.02	Inches	
Display Area	819.6 (H) x 460.8(V)	mm	
Outline Dimension	877.0(H) x 514.6(V) x 54.7(D)	mm	With inverter
Driver Element	a-Si TFT active matrix		
Display Colors	16.7M	Colors	
Number of Pixels	1366x768	Pixel	
Pixel Arrangement	RGB vertical stripe		
Pixel pitch	0.6(H) x 0.6(W)		
Surface Treatment	Hard-Coating (3H), Anti-Glare		
RoHS	RoHS Compliance		



2. Absolute Maximum Ratings

The following are maximum values which, if exceeded, may cause faulty operation or damage to the unit.

Parameter	Symbol	Min.	Max.	Unit	Note
Logic/LCD Driving Voltage	V_{DD}	-0.3	14	V.	1
Input Voltage of Signal	V_{in}	-0.3	4	V.	1
BLU Input Voltage	V_{DDB}	-0.3	27	V	1
BLU Control Voltage	BL_{ON}	-0.3	7.0	V	1
Operating Temperature	T_{OP}	0	50	°C	2
Storage Temperature	H_{ST}	-20	60	°C	2
Operating Ambient Humidity	H_{OP}	10	90	%RH	2
Storage Humidity	H_{ST}	10	90	%RH	2

Note 1: Duration = 50msec

Note 2 : Maximum Wet-Bulb should be 39°C and No condensation.

The relative humidity must not exceed 90% non-condensing at temperatures of 40°C or less. At temperatures greater than 40°C, the wet bulb temperature must not exceed 39°C.

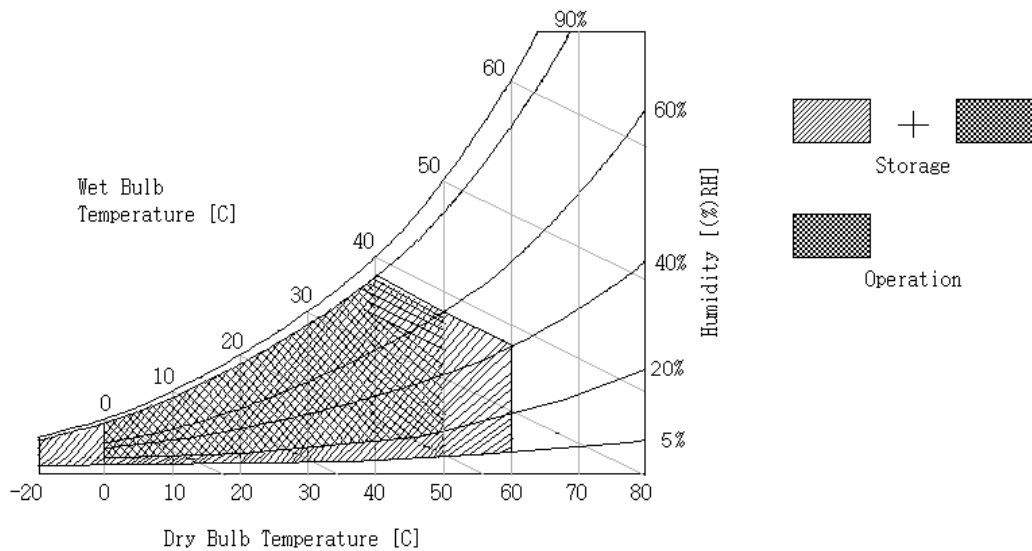

3. Electrical Specification

3-1 Electrical Characteristics

The T370XW02 V5 requires two power inputs. One is employed to power the LCD electronics and to drive the TFT array and liquid crystal. The second input which powers the CCFL, is typically generated by an inverter.

Parameter	Symbol	Value			Unit	Note
		Min.	Typ.	Max.		
LCD						
Power Supply Input Voltage	V_{LCD}	10.8	12.0	13.2	V.	
Power Supply Input Current	I_{LCD}	-	0.55	0.66	A.	1
Power Consumption	P_C	-	6.6	7.92	W	1
Inrush Current	I_{RUSH}	-	-	4	A	2
Backlight Power Consumption		-	120	132	W	
Lamp Life Time		50000	60,000		hr	3

Note:

1. $V_{CC}=12.0V$, $f_v = 60Hz$, $f_{CLK}=81.5Mhz$, $25^{\circ}C$, Test pattern : White pattern.
2. Duration = 400 μs

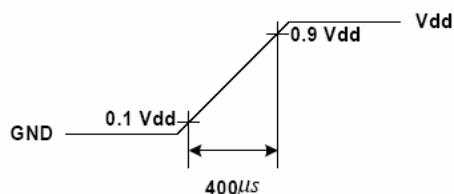

3. The performance of the Lamp in LCM, for example life time or brightness, is extremely influenced by the characteristics of the DC-AC Inverter. So all the parameters of an inverter should be carefully designed so as not to produce too much leakage current from high-voltage output of the inverter. When you design or order the inverter, please make sure unwanted lighting caused by the mismatch of the lamp and the inverter (no lighting, flicker, etc) never occurs. When you confirm it, the LCD Assembly should be operated in the same condition as installed in your instrument.
4. Do not attach a conducting tape to lamp connecting wire. If the lamp wire attach to conducting tape, TFT-LCD Module have a low luminance and the inverter has abnormal action because leakage current occurs between lamp wire and conducting tape.
5. The relative humidity must not exceed 80% non-condensing at temperatures of $40^{\circ}C$ or less. At temperatures greater than $40^{\circ}C$, the wet bulb temperature must not exceed $39^{\circ}C$. When operate at low temperatures, the brightness of CCFL will drop and the life time of CCFL will be reduced.



3-2 Interface Connections

LCD Connector (CN1): JAE FI-X30SSL-HF or equivalent. AUO will notice Toshiba if we change the LCD connector from JAE to others.

LVDS Transmitter:

Pin No	Symbol	Function
1	V _{LCD}	Power Supply +12.0V
2	V _{LCD}	Power Supply +12.0V
3	V _{LCD}	Power Supply +12.0V
4	V _{LCD}	Power Supply +12.0V
5	GND	Ground
6	GND	Ground
7	GND	Ground
8	GND	Ground
9	SEL LVDS	LVDS Data Format Selection
10	NC	NC
11	GND	Ground
12	RIN0-	Negative LVDS Data Input
13	RIN0+	Positive LVDS Data Input
14	GND	Ground
15	RIN1-	Negative LVDS Data Input
16	RIN1+	Positive LVDS Data Input
17	GND	Ground
18	RIN2-	Negative LVDS Data Input
19	RIN2+	Positive LVDS Data Input
20	GND	Ground
21	CLKIN-	Negative LVDS Data Input
22	CLKIN+	Positive LVDS Data Input
23	GND	Ground
24	RIN3-	Negative LVDS Data Input
25	RIN3+	Positive LVDS Data Input
26	GND	Ground
27	Reserved	Leave it Open
28	Reserved	Leave it Open
29	Reserved	Leave it Open
30	Reserved	Leave it Open



I LVDS Data Format Selection

1. SEL LVDS = High (3.3V) = JAIDA

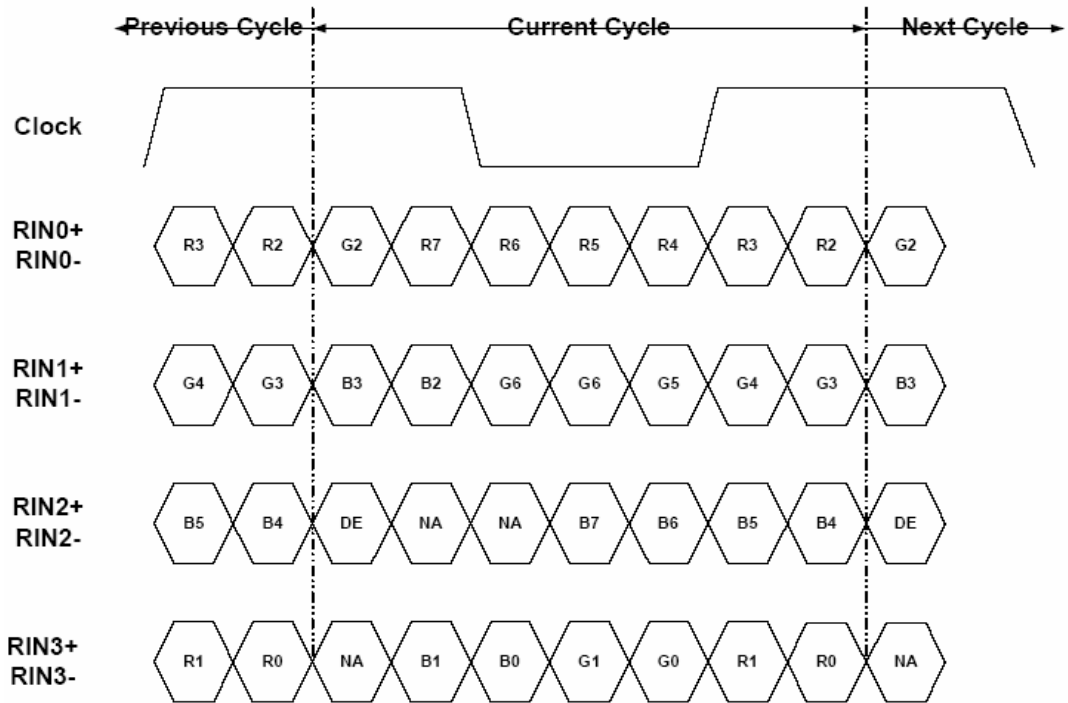

2. SEL LVDS = Low (GND) or Open = NS

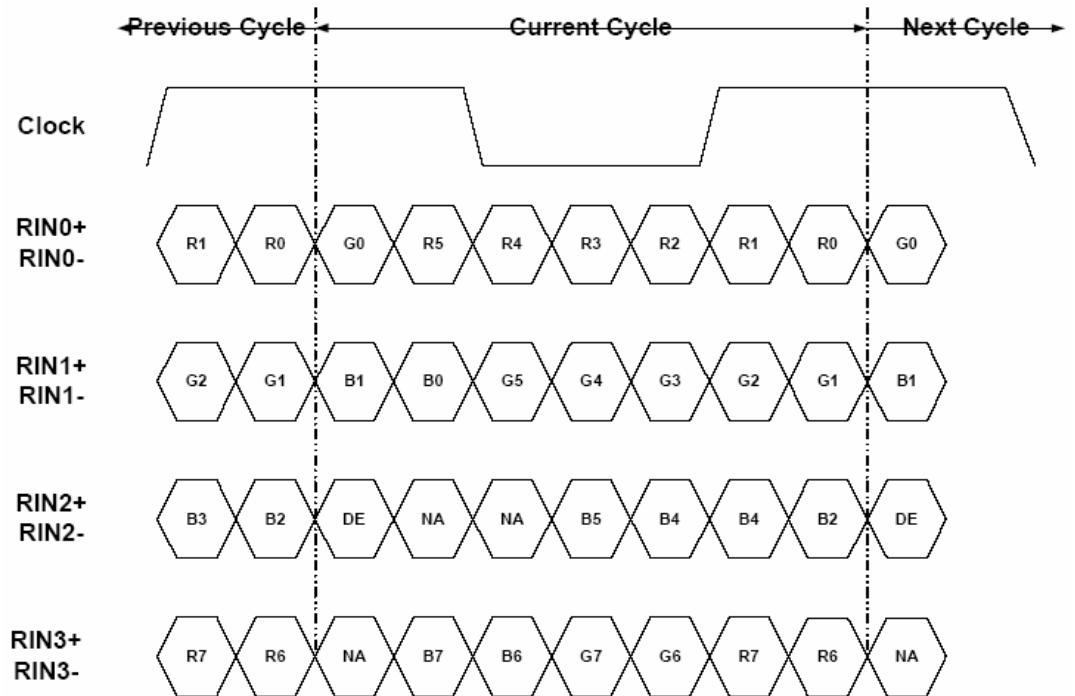



I BACKLIGHT CONNECTOR PIN CONFIGURATION -

1. Electrical specification

No	Item	Symbol	Test Condition	Min	Typ	Max	Unit	Note	
1	Power Input Voltage	V_{BL}		21.6	24	26.4	V		
2	Power Input Current	I_{BL}	VDD=24V,100%brightness	-	5	5.5	A		
3	Power Consumption	P_{BL}	VDD=24V,100%brightness	-	120	132	W		
4	Input Inrush current	I_{RUSH}	VDD=24V,100%brightness			8.5	A	*2	
5	Lamp Oscillating Frequency	F_{LO}	VDD=24V,100%brightness	34	36	38	kHz		
6	Dimming Frequency	F_{BLD}	VDD=24V	150	-	300	Hz		
7	On/Off Control Voltage	On	BL_{ON}	VDD=24V	2	-	5.25	V	*3
		Off	BL_{ON}	VDD=24V	0	-	0.8	V	
8	DC Dimming Control	Max	Vdim	VDD=24V	-	3.3	-	V	*1
		Min	Vdim	VDD=24V	-	0	-	V	
9	PWM Dimming Control	Max	E_PWM	VDD=24V	-	100	-	%	
		Min	E_PWM	VDD=24V	-	30	-	%	Duty Ratio

($T_a=25\pm 2^{\circ}C$)

※1: Connection of brightness control terminal

Bright control by the voltage

0V : Min. brightness

3.3V : Max. brightness

※2: rise time must >20 ms

※3: BLON Logic

H(5V) : Back Light ON

L (0V) : Back Light OFF

OPEN : Back Light OFF



2. Input specification

CN1 : S14B-PH-SM3-TB(JST)

CN2 : S10B-PH-SM3-TB(JST)

No	Signal Name	Feature	No	Signal Name	Feature
1	V _{BL}	+24V	1	V _{BL}	+24V
2	V _{BL}	+24V	2	V _{BL}	+24V
3	V _{BL}	+24V	3	V _{BL}	+24V
4	V _{BL}	+24V	4	V _{BL}	+24V
5	V _{BL}	+24V	5	V _{BL}	+24V
6	GND	GND	6	GND	GND
7	GND	GND	7	GND	GND
8	GND	GND	8	GND	GND
9	GND	GND	9	GND	GND
10	GND	GND	10	GND	GND
11	V _{dim}	Brightness control signal input (0V: min ~ 3.3V:Max)			
12	BL On/Off	5V : On, 0V : Off			
13	E-PWM Dim	External PWM Dimming Control			
14	SEL pin	High(2~5V) : internal PWM (pin 11) Low(0~0.8) : external PWM (pin13)			

*¹ PWM SEL setting

Pin \ Setting	Pin 14 : High	Pin 14 : Low
V _{DM} (pin 11)	Internal PWM Dimming	Analog Dimming
E-PWM (pin13)	Disable	External PWM Dimming



3-3 Input Timing Specifications (DE only node)

60Hz Driving Timing

Signal	Item	Symbol	Min.	Type.	Max.	Unit
Vertical Section	Period	Tv	789	806	822	Th
	Active	Tdisp(V)	768			Th
	Blanking	Tblk(V)	21	38	54	Th
Horizontal Section	Period	Th	1414	1560	1722	Tclk
	Active	Tdisp(H)	1366			Tclk
	Blanking	Tblk(H)	48	194	356	Tclk
	H Freq	Freq.	45.76	48.36	50.96	kHz
Clock	Period	Tclk	15.45	13.26	11.39	ns
	Frequency	1/Tclk	64.71	75.44	87.76	MHz
Vertical Frequency		Freq.	58	60	62	Hz

50Hz Driving Timing

Signal	Item	Symbol	Min.	Type.	Max.	Unit
Vertical Section	Period	Tv	940	960	980	Th
	Active	Tdisp(V)	768			Th
	Blanking	Tblk(V)	172	192	212	Th
Horizontal Section	Period	Th	1414	1480	1560	Tclk
	Active	Tdisp(H)	1366			Tclk
	Blanking	Tblk(H)	48	114	194	Tclk
	H Freq	Freq.	46.06	48	49.98	kHz
Clock	Period	Tclk	15.35	14.08	12.83	ns
	Frequency	1/Tclk	65.13	71.04	77.97	MHz
Vertical Frequency		Freq.	49	50	51	Hz



3-4 Signal Timing Waveforms

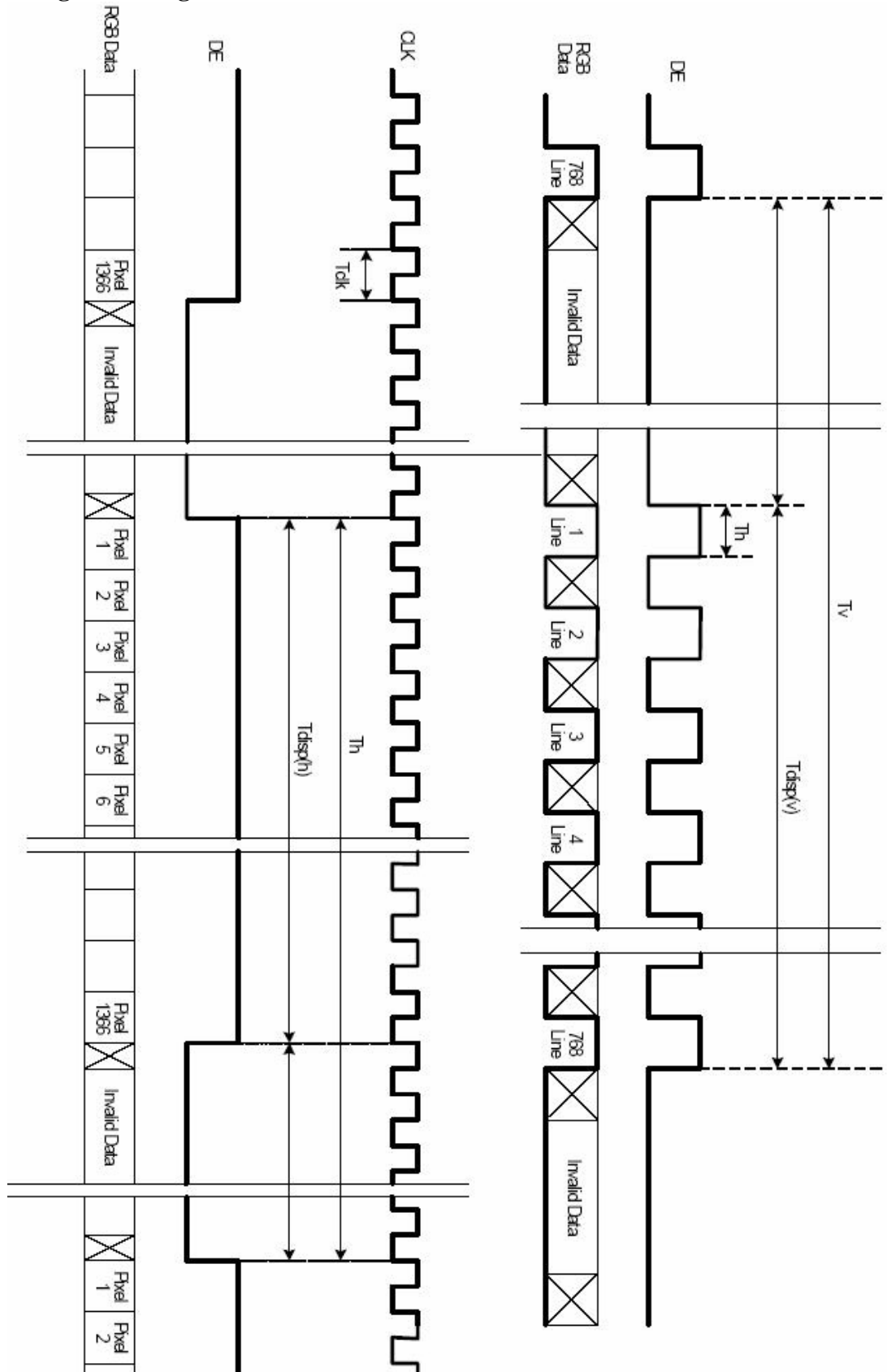



3-5 Color Input Data Reference

The brightness of each primary color (red, green and blue) is based on the 8 bit gray scale data input for the color; the higher the binary input, the brighter the color. The table below provides a reference for color versus data input.

COLOR DATA REFERENCE

Color		Input Color Data																							
		RED								GREEN								BLUE							
		MSB				LSB				MSB				LSB				MSB				LSB			
		R7	R6	R5	R4	R3	R2	R1	R0	G7	G6	G5	G4	G3	G2	G1	G0	B7	B6	B5	B4	B3	B2	B1	B0
Basic Color	Black	0	0	0	0	0	0	0	0	0	0	0	0	0	0	0	0	0	0	0	0	0	0	0	
	Red(255)	1	1	1	1	1	1	1	1	0	0	0	0	0	0	0	0	0	0	0	0	0	0	0	
	Green(255)	0	0	0	0	0	0	0	0	1	1	1	1	1	1	1	1	0	0	0	0	0	0	0	
	Blue(255)	0	0	0	0	0	0	0	0	0	0	0	0	0	0	0	0	1	1	1	1	1	1	1	
	Cyan	0	0	0	0	0	0	0	0	1	1	1	1	1	1	1	1	1	1	1	1	1	1	1	
	Magenta	1	1	1	1	1	1	1	1	0	0	0	0	0	0	0	0	1	1	1	1	1	1	1	
	Yellow	1	1	1	1	1	1	1	1	1	1	1	1	1	1	1	0	0	0	0	0	0	0	0	
White	1	1	1	1	1	1	1	1	1	1	1	1	1	1	1	1	1	1	1	1	1	1	1		
RED	RED(000)	0	0	0	0	0	0	0	0	0	0	0	0	0	0	0	0	0	0	0	0	0	0		
	RED(001)	0	0	0	0	0	0	0	1	0	0	0	0	0	0	0	0	0	0	0	0	0	0		

	RED(254)	1	1	1	1	1	1	1	0	0	0	0	0	0	0	0	0	0	0	0	0	0	0		
	RED(255)	1	1	1	1	1	1	1	1	0	0	0	0	0	0	0	0	0	0	0	0	0	0		
GREEN	GREEN(000)	0	0	0	0	0	0	0	0	0	0	0	0	0	0	0	0	0	0	0	0	0	0		
	GREEN(001)	0	0	0	0	0	0	0	0	0	0	0	0	0	0	1	0	0	0	0	0	0	0		

	GREEN(254)	0	0	0	0	0	0	0	0	1	1	1	1	1	1	1	0	0	0	0	0	0	0		
	GREEN(255)	0	0	0	0	0	0	0	0	1	1	1	1	1	1	1	0	0	0	0	0	0	0		
BLUE	BLUE(000)	0	0	0	0	0	0	0	0	0	0	0	0	0	0	0	0	0	0	0	0	0	0		
	BLUE(001)	0	0	0	0	0	0	0	0	0	0	0	0	0	0	0	0	0	0	0	0	0	1		

	BLUE(254)	0	0	0	0	0	0	0	0	0	0	0	0	0	0	0	1	1	1	1	1	1	0		
	BLUE(255)	0	0	0	0	0	0	0	0	0	0	0	0	0	0	0	1	1	1	1	1	1	1		

3-6 Power Sequence

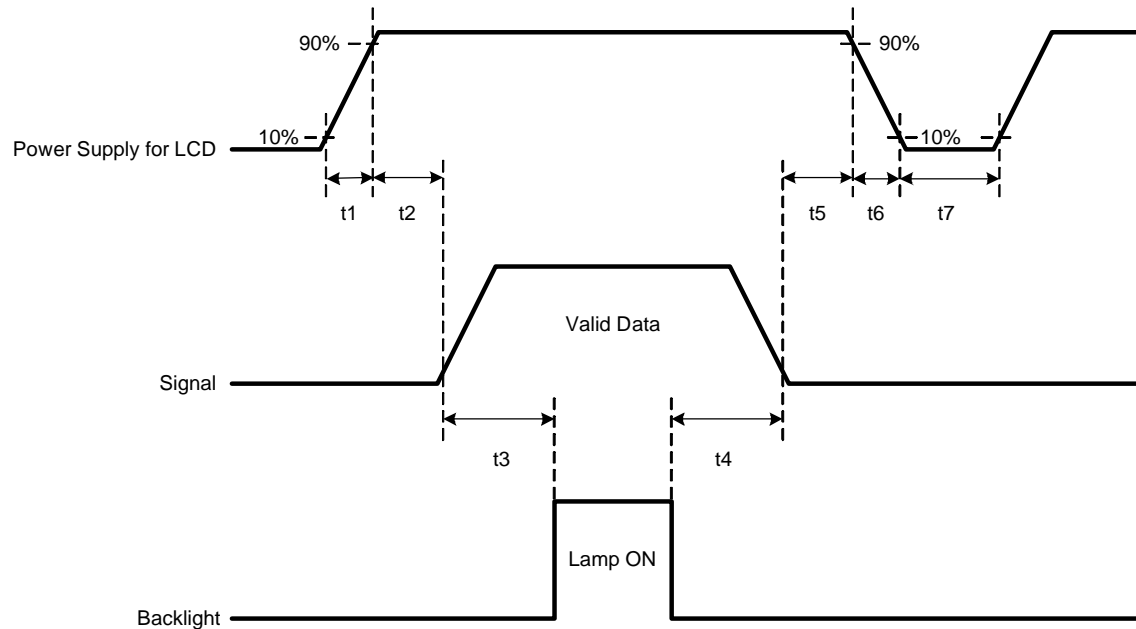

Parameter	Values			Units
	Min.	Typ.	Max.	
t1	0.4		20	ms
t2	20		50	ms
t3	700 or 200 (*1)			ms
t4	10			ms
t5	1		50	ms
t6			300	ms
t7	1			s

*1: If t3=200ms, input black signal till 700ms from system is necessary.

In case of t3<200ms, the abnormal display will be happened. But it will not damage timing controller.

Note:

The timing controller will not be damaged in case of TV set AC input power suddenly shut down.

Once power reset, it should follow power sequence as spec. definition.

- (1) Apply the lamp voltage within the LCD operation range. When the back-light turns on before the LCD operation or the LCD turns off before the back-light turns off, the display may momentarily become abnormal screen.



3.6.2 Power Sequence for Inverter

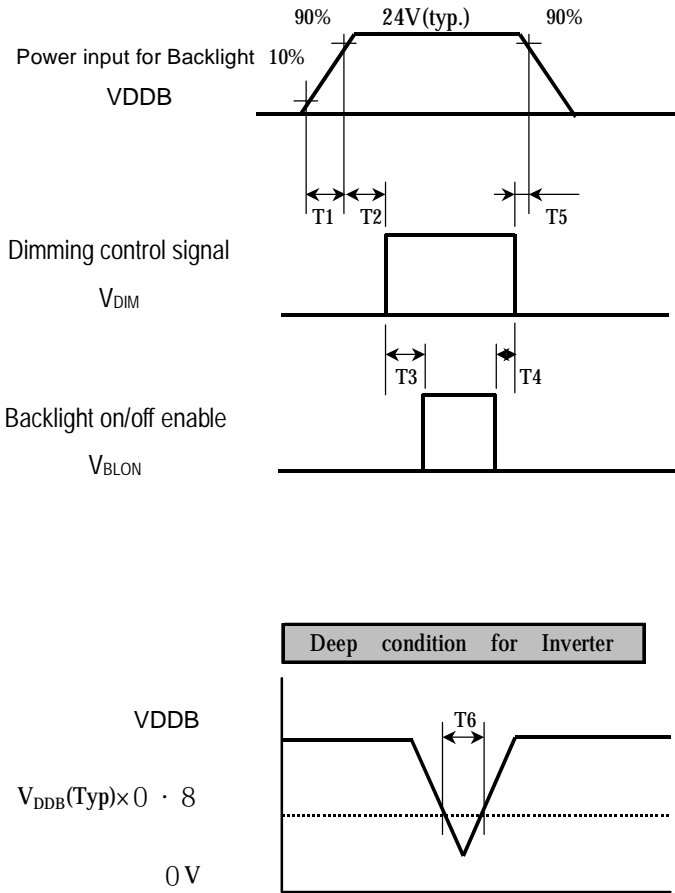

Parameter	Values			Units
	Min.	Typ.	Max.	
T1	20	-	-	ms
T2	50	-	-	ms
T3	0	-	-	ms
T4	0	-	-	ms
T5	0	-	-	ms
T6	-	-	10	ms

4. Optical Specification

Optical characteristics are determined after the unit has been ‘ON’ and stable for approximately 30 minutes in a dark environment at 25°C. The values specified are at an approximate distance 50cm from the LCD surface at a viewing angle of Φ and θ equal to 0°.

Fig.1 Presents additional information concerning the measurement equipment and method.

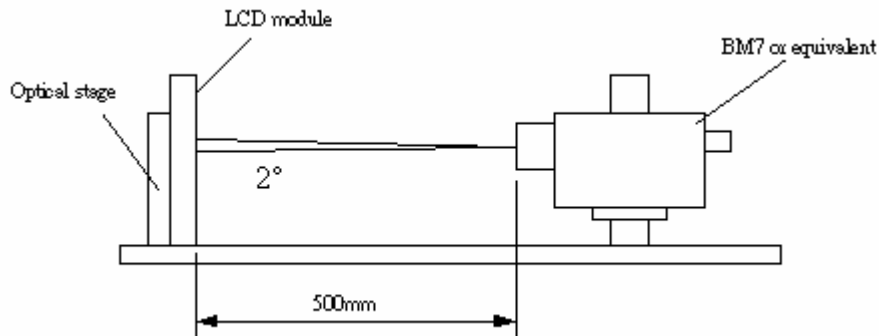

Parameter	Symbol	Values			Units	Notes	
		Min.	Typ.	Max.			
Contrast Ratio	CR	1200	1500	-		1	
Surface Luminance, white	LWH	400	500	-	cd/m ²	2	
Luminance Variation	δ_{WHITE} 9 p	-	-	1.3		3	
Response Time	Rise Time	T_{R}	-	15	18	ms	4
	Decay Time	T_{D}	-	5	7	ms	
	G to G	T_{γ}	-	8	35	ms	5
Color Chromaticity	RED	R_X	Typ -0.03	0.640	Typ +0.03		
		R_Y		0.330			
	GREEN	G_X		0.290			
		G_Y		0.600			
	BLUE	B_X		0.150			
		B_Y		0.060			
	WHITE	W_X		0.280			
		W_Y		0.290			
Viewing Angle							
	x axis, right($\varphi=0^\circ$)	θ_r	-	89	-	Degree	6
	x axis, left($\varphi=180^\circ$)	θ_l	-	89	-		
	y axis, up($\varphi=90^\circ$)	θ_u	-	89	-		
	y axis, down ($\varphi=0^\circ$)	θ_d	-	89	-		



Note: 1. Contrast Ratio (CR) is defined mathematically as:

$$\text{Contrast Ratio} = \frac{\text{Surface Luminance with all white pixels}}{\text{Surface Luminance with all black pixels}}$$

2. Surface luminance is luminance value at point 1 across the LCD surface 50cm from the surface with all pixels displaying white. From more information see FIG 2.
3. The variation in surface luminance, $\delta_{\text{WHITE(9P)}}$ is defined (center of Screen) as:

$$\delta_{\text{WHITE(9P)}} = \frac{\text{Maximum}(L_{\text{on1}}, L_{\text{on2}}, \dots, L_{\text{on9}})}{\text{Minimum}(L_{\text{on1}}, L_{\text{on2}}, \dots, L_{\text{on9}})}$$
 More information please see Fig.3
4. Response time is the time required for the display to transition from Black to White (Rise Time, T_{rR}) and from White to Black (Decay Time, T_{rD}). For additional information see FIG4.
5. T_{γ} is the response time between any two gray scale and is based on $f_v=60\text{Hz}$ to optimize
6. Viewing angle is the angle at which the contrast ratio is greater than 10. The angles are determined for the horizontal or x axis and the vertical or y axis with respect to the z axis which is normal to the LCD surface. For more information see FIG5.

FIG. 2 Luminance

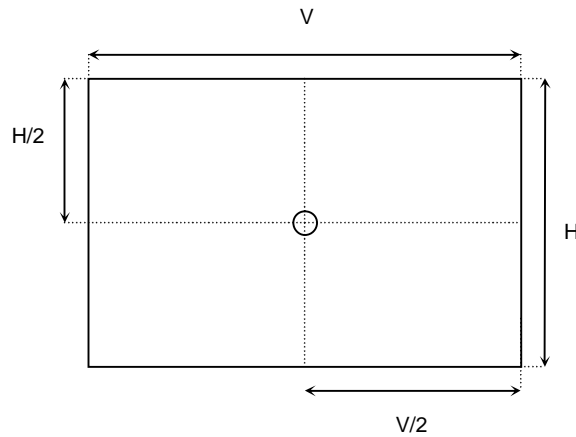

FIG. 3 Luminance variation

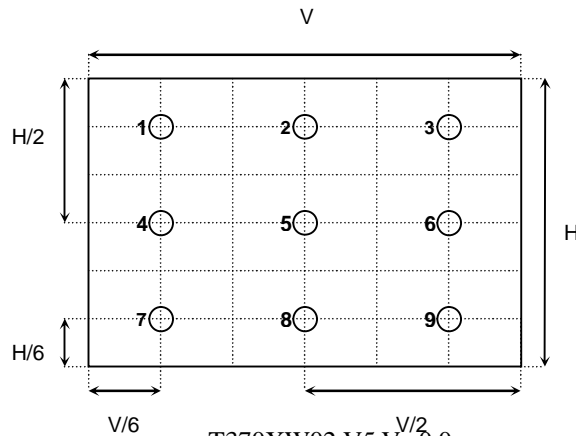

FIG.4 Response Time

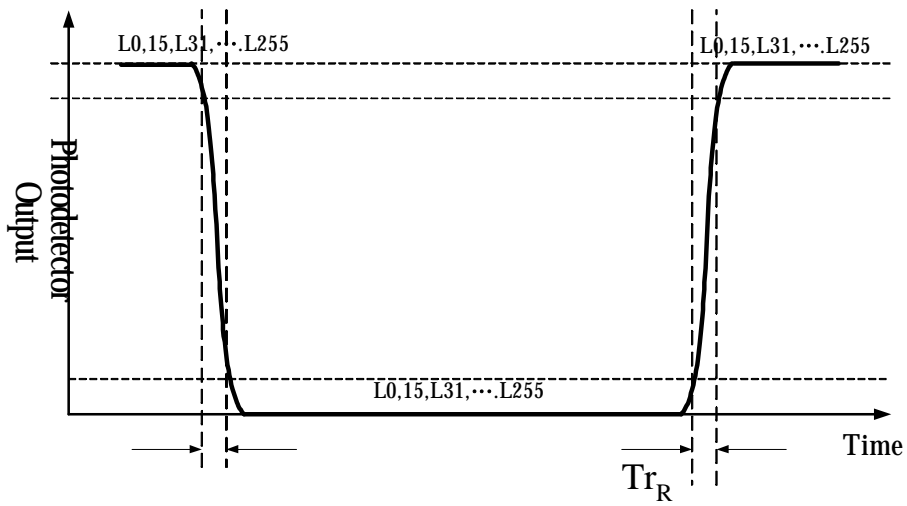
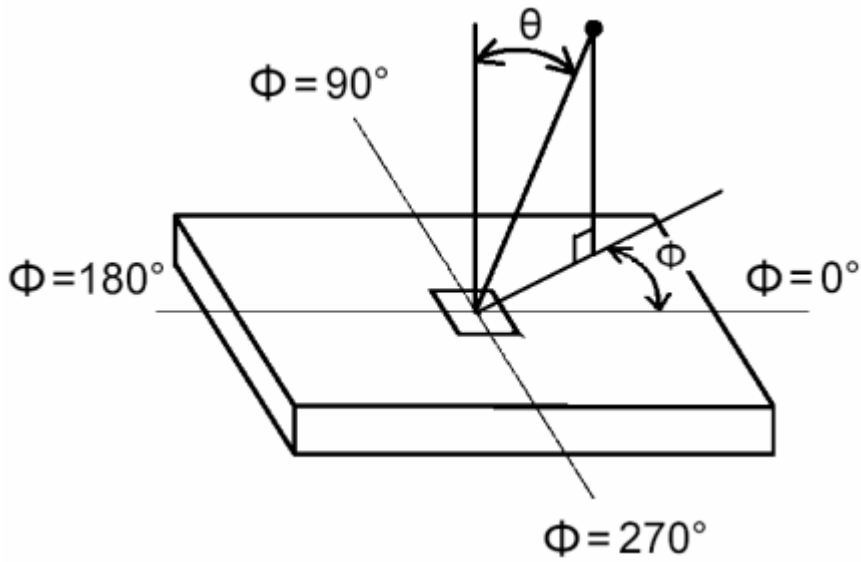

FIG.4 Viewing angle





5. Mechanical Characteristics

The contents provide general mechanical characteristics for the model T370XW02 V5. In addition the figures in the next page are detailed mechanical drawing of the LCD.

Outline Dimension	Horizontal	877.0 mm
	Vertical	514.6 mm
	Depth	54.7 mm(with inverter)
Bezel Opening Area	Horizontal	827.8 mm
	Vertical	469.4 mm
Display Active Area	Horizontal	819.6 mm
	Vertical	460.8 mm
Weight	8900g (Typ.)	
Surface Treatment	Hard-Coating (3H), Anti-Glare,	



6. Reliability

Environment test condition

No	Test Item	Condition
1	High temperature storage test	Ta=60°C 240h
2	Low temperature storage test	Ta= -20°C 240h
3	High temperature operation test	Ta=50°C 50%RH 240h
4	Low temperature operation test	Ta=0°C 240h
5	Vibration test (non-operating)	Wave form: random Vibration level: 1.5G RMS Bandwidth: 10-500Hz, Duration: X, Y, Z 20min One time each direction
6	Shock test (non-operating)	Shock level: 50G Waveform: half sine wave, 11ms Direction: ±X, ±Y, ±Z One time each direction
7	Vibration test (with carton)	Wave form: random Vibration level: 1.5G RMS Bandwidth: 10-500Hz, Duration: X, Y, Z 30min One time each direction
8	Drop test (with carton)	Height: 53.3cm 1 corner, 3 edges, 6 surfaces (ASTMD4169-I)

{ Result Evaluation Criteria }

There should be no change which might affect the practical display function when the display quality test is conducted under normal operating condition.



7. International Standard

7-1. Safety

- (1) UL1950 Third Edition, Underwriters Laboratories, Inc. Jan. 28, 1995

Standard for Safety of Information Technology Equipment Including electrical Business Equipment.

- (2) CAN/CSA C22.2 No. 950-95/60950 Third Edition, Canadian Standards Association,

Standard for Safety of Information Technology Equipment Including Electrical Business Equipment.

- (3) IEC 60065 : 2001

IEC 60950-1: 2001

European Committee for Electrotechnical Standardization (CENELEC)



EUROPEAN STANDARD for Safety of Information Technology Equipment Including Electrical Business Equipment.

7-2. EMC

- a) ANSI C63.4 “Methods of Measurement of Radio-Noise Emissions from Low-Voltage Electrical and Electrical Equipment in the Range of 9kHz to 40GHz. “American National standards Institute (ANSI), 1992
- b) C.I.S.P.R “Limits and Methods of Measurement of Radio Interface Characteristics of Information Technology Equipment.” International Special committee on Radio Interference.
- c) EN 55022 “Limits and Methods of Measurement of Radio Interface Characteristics of Information Technology Equipment.” European Committee for Electrotechnical Standardization. (CENELEC), 1998

7-3. Green

Green Mark Description:

- a) For Pb Free products, AUO will add  for identification.
- b) For RoHS compatible products, AUO will add  for identification.

Note. The Green Mark will be present only when the green documents have been ready by AUO Internal Green Team. (The definition of green design follows the AUO green design checklist.)



8. Packing

Label : 83mm * 23mm



- 1 **MW6660500026- PMA00**
MW66605: Production Lot
00026: Panel serial number
PMA:AUO internal code
- 2 Manufactured 06/22: 2006 week 22

Carton Label: 100mm * 120mm

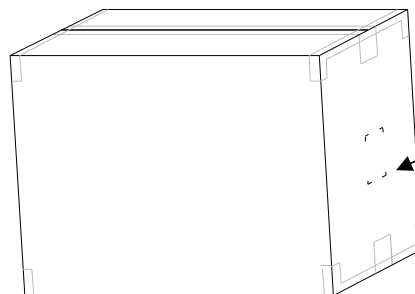
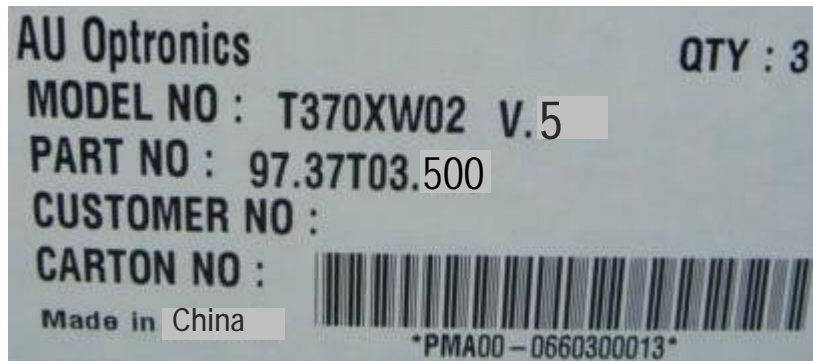

Carton label alignment mark

Carton Size

965(L)mm*280(W)mm*662(H)mm

Pallet Size

1130(L)mm*980(W)mm*123(H)mm

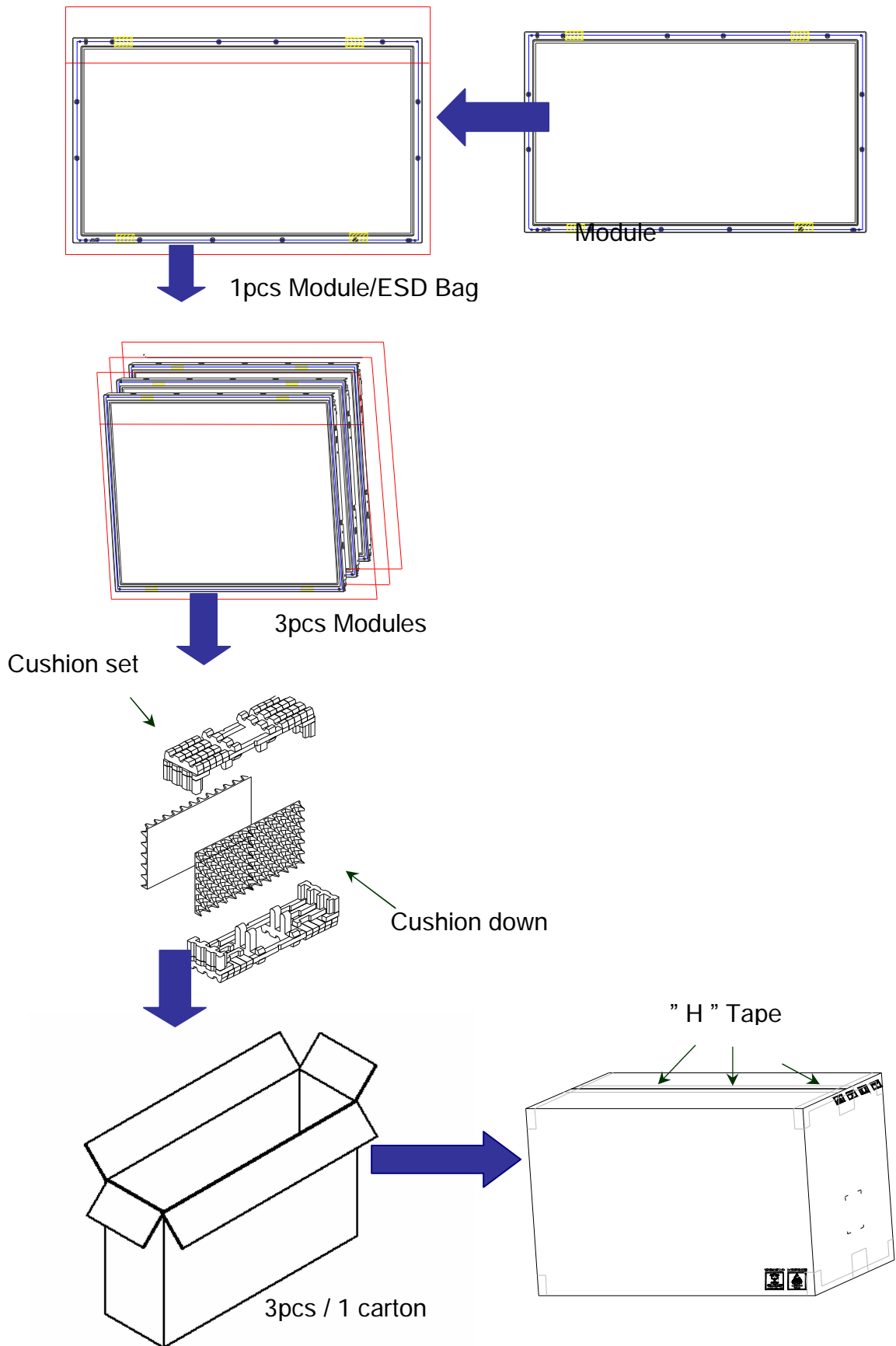



By Air : 1 pallet + 4 box 2 layers (8*3=24 pcs module)

By Sea : 1 pallet + 4 box 3 layers (12*3=36 pcs module)

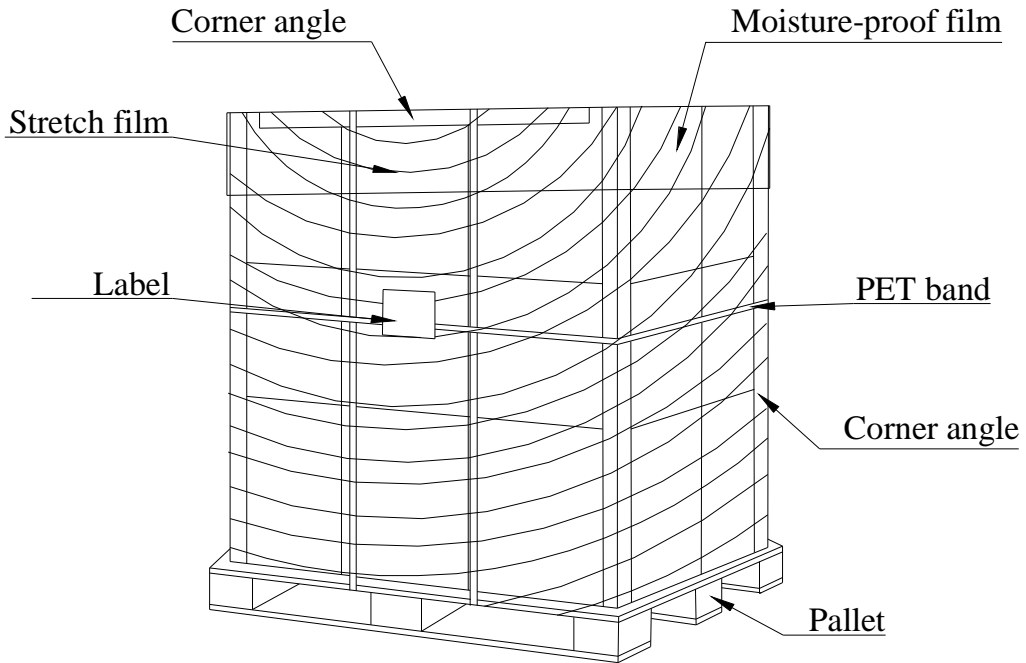



9. PRECAUTIONS

Please pay attention to the followings when you use this TFT LCD module.

9-1 MOUNTING PRECAUTIONS

- (1) You must mount a module using holes arranged in four corners or four sides.
- (2) You should consider the mounting structure so that uneven force (ex. Twisted stress) is not applied to module. And the case on which a module is mounted should have sufficient strength so that external force is not transmitted directly to the module.
- (3) Please attach the surface transparent protective plate to the surface in order to protect the polarizer. Transparent protective plate should have sufficient strength in order to resist external force.
- (4) You should adopt radiation structure to satisfy the temperature specification.
- (5) Acetic acid type and chlorine type materials for the cover case are not desirable because the former generates corrosive gas of attacking the polarizer at high temperature and the latter causes circuit break by electro-chemical reaction.
- (6) Do not touch, push or rub the exposed polarizers with glass, tweezers or anything harder than HB pencil lead. And please do not rub with dust clothes with chemical treatment. Do not touch the surface of polarizer for bare hand or greasy cloth. (Some cosmetics are detrimental to the polarizer.)
- (7) When the surface becomes dusty, please wipe gently with absorbent cotton or other soft materials like chamois soaks with petroleum benzene. Normal-hexane is recommended for cleaning the adhesives used to attach front/ rear polarizers. Do not use acetone, toluene and alcohol because they cause chemical damage to the polarizer.
- (8) Wipe off saliva or water drops as soon as possible. Their long time contact with polarizer causes deformations and color fading.
- (9) Do not open the case because inside circuits do not have sufficient strength.

9-2 OPERATING PRECAUTIONS

- (1) The spike noise causes the mis-operation of circuits. It should be lower than following voltage:
 $V = \pm 200\text{mV}$ (Over and under shoot voltage)
- (2) Response time depends on the temperature. (In lower temperature, it becomes longer.)
- (3) Brightness depends on the temperature. (In lower temperature, it becomes lower.) And in lower temperature, response time (required time that brightness is stable after turned on) becomes longer.
- (4) Be careful for condensation at sudden temperature change. Condensation makes damage to polarizer or electrical contacted parts. And after fading condensation, smear or spot will occur.
- (5) When fixed patterns are displayed for a long time, remnant image is likely to occur.
- (6) Module has high frequency circuits. Sufficient suppression to the electromagnetic interference shall be done by system manufacturers. Grounding and shielding methods may be important to minimize the interface.

9-3 ELECTROSTATIC DISCHARGE CONTROL

Since a module is composed of electronic circuits, it is not strong to electrostatic discharge. Make certain that treatment persons are connected to ground through wrist band etc. And don't touch interface pin directly.



9-4 PRECAUTIONS FOR STRONG LIGHT EXPOSURE

Strong light exposure causes degradation of polarizer and color filter.

9-5 STORAGE

When storing modules as spares for a long time, the following precautions are necessary.

- (1) Store them in a dark place. Do not expose the module to sunlight or fluorescent light. Keep the temperature between 5°C and 35°C at normal humidity.
- (2) The polarizer surface should not come in contact with any other object. It is recommended that they be stored in the container in which they were shipped.

9-6 HANDLING PRECAUTIONS FOR PROTECTION FILM

- (1) The protection film is attached to the bezel with a small masking tape. When the protection film is peeled off, static electricity is generated between the film and polarizer. This should be peeled off slowly and carefully by people who are electrically grounded and with well ion-blown equipment or in such a condition, etc.
- (2) When the module with protection film attached is stored for a long time, sometimes there remains a very small amount of glue still on the Bezel after the protection film is peeled off.
- (3) You can remove the glue easily. When the glue remains on the Bezel or its vestige is recognized, please wipe them off with absorbent cotton waste or other soft material like chamois soaked with normal-hexane.