



SmarterGlass

state-of-the-art display solutions

www.smarterglass.com
978 997 4104
sales@smarterglass.com



Product Description: T420HW01 V1 TFT-LCD PANEL

AUO Model Name: T420HW01 V1

Customer Part No/Project Name:

Customer Signature	Date	AUO	Date
		Approved By: Yu Chieh Lin	
		Reviewed By: Hong Jye Hong	
		Prepared By: Stanley Chiang	



Document Version: 1.1

Date:2007/3/22

Product Functional Specification

42" Full-HD Color TFT-LCD Module

Model Name: T420HW01 V1

(*) Preliminary Specification

() Final Specification

Note : This specification is subject to change without notice.



Contents

No	ITEM
	COVER
	CONTENTS
	RECORD OF REVISIONS
1	GENERAL DESCRIPTION
2	ABSOLUTE MAXIMUM RATINGS
3	ELECTRICAL SPECIFICATIONS
3-1	ELECTRICAL CHARACTERISTICS
3-2	INTERFACE CONNECTIONS
3-3	SIGNAL TIMING SPECIFICATIONS
3-4	SIGNAL TIMING WAVEFORMS
3-5	COLOR INPUT DATA REFERENCE
3-6	POWER SEQUENCE
4	OPTICAL SPECIFICATIONS
5	MECHANICAL CHARACTERISTICS
6	RELIABILITY
7	INTERNATIONAL STANDARDS
7-1	SAFETY
7-2	EMC
8	PACKING
9	PRECAUTIONS



1. General Description

This specification applies to the 42 inch Color TFT-LCD Module T420HW01 V1. This LCD module has a TFT active matrix type liquid crystal panel 1920x1080 pixels, and diagonal size of 42 inch. This module supports 1920x1080 Full-HD mode (Non-interlace).

Each pixel is divided into Red, Green and Blue sub-pixels or dots which are arranged in vertical stripes. Gray scale or the brightness of the sub-pixel color is determined with a 8-bit gray scale signal for each dot.

The T420HW01 V1 has been designed to apply the 8-bit 2 channel LVDS interface method. It is intended to support displays where high brightness, wide viewing angle, high color saturation, and high color depth are very important.

* General Information

Items	Specification	Unit	Note
Active Screen Size	42.02	inches	
Display Area	930.24(H) x 523.26(V)	mm	
Outline Dimension	983.0(H) x 576.0(V) x 52.3(D)	mm	With inverter
Driver Element	a-Si TFT active matrix		
Display Colors	16.7M	Colors	
Number of Pixels	1920 x 1080	Pixel	
Pixel Pitch	0.4845	mm	
Pixel Arrangement	RGB vertical stripe		
Display Mode	Normally Black		
Lamp quantity, type	20pcs, Straight type	pcs	
Surface Treatment	AG, 3H		



Absolute Maximum Ratings

The following are maximum values which, if exceeded, may cause faulty operation or damage to the unit.

Item	Symbol	Min	Max	Unit	Note
Power Supply Input Voltage	V _{DD}	-0.3	14	[Volt]	1
Logic Input Voltage	V _{in}	-0.3	3.6	[Volt]	1
BLU Input Voltage	V _{DDB}	-0.3	26.4	[Volt]	1
BLU Brightness Control Voltage	BL _{ON}	-0.3	3.6	[Volt]	1
Ambient Operating Temperature	T _{OP}	0	+50	[°C]	2
Ambient Operating Humidity	H _{OP}	10	80	[%RH]	2
Storage Temperature	T _{ST}	-20	+60	[°C]	2
Storage Humidity	H _{ST}	10	80	[%RH]	2
Shock (non-operation)		-	50	G	3
Vibration (non-operation)		-	1.5	G	4
Thermal shock		-20	60	C	5
Altitude test	50000feet (12Kpa)				

Note 1 : Duration = 50msec

Note 2 : Maximum Wet-Bulb should be 50 °C and No condensation.

Note 3 : Half sine wave, shock level : 50G(11ms), direction : ±x, ±y, ±z (one time each direction)

Note 4 : Wave form : Sin, vibration level : 1.5G RMS, Bandwidth : 10~500Hz

Duration : X,Y,Z 30min (one time each direction)

Note 5 : -20C/1hr ~ 60C/1hr, 100 cycles

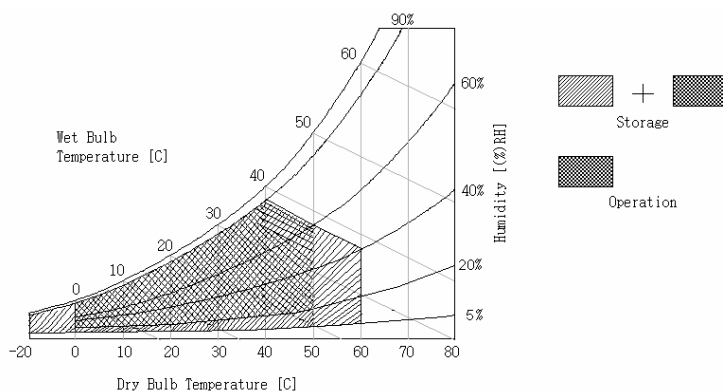



2. Electrical Specification

The T420HW01 requires two power inputs. One is employed to power the LCD electronics and to drive the TFT array and liquid crystal. The second input, which powers the CCFL, is typically generated by an inverter.

3-1 Electrical Characteristics

Parameter		Symbol	Values			Unit	Notes
			Min	Typ	Max		
LCD:							
Power Supply Input Voltage		Vdd	10.8	12	13.2	Vdc	
Power Supply Input Current		Idd	-	1		A	1
Power Consumption		Pc	-	12		Watt	1
Inrush Current		I _{RUSH}	-	-	4	A	5
LVDS Interface	Differential Input High Threshold Voltage	V _{TH}			+100	mV	4
	Differential Input Low Threshold Voltage	V _{TL}	-100			mV	4
	Common Input Voltage	V _{CIM}	0.6	1.2	1.8	V	
	CMOS Input High Threshold Voltage	V _{IH} (High)	2.0		3.3	Vdc	
CMOS Input Low Threshold Voltage	V _{IL} (Low)	0		1	Vdc		
Backlight Power Consumption			-	(165)	(170)	Watt	2
Life Time			50000	60000		Hours	3

The performance of the Lamp in LCM, for example life time or brightness, is extremely influenced by the characteristics of the DC-AC Inverter. So all the parameters of an inverter should be carefully designed so as not to produce too much leakage current from high-voltage output of the inverter. When you design or order the inverter, please make sure unwanted lighting caused by the mismatch of the lamp and the inverter (no lighting, flicker, etc) never occurs. When you confirm it, the LCD Assembly should be operated in the same condition as installed in your instrument.



Do not attach a conducting tape to lamp connecting wire. If the lamp wire attach to conducting tape, TFT-LCD Module have a low luminance and the inverter has abnormal action because leakage current occurs between lamp wire and conducting tape.

The relative humidity must not exceed 80% non-condensing at temperatures of 40 °C or less. At temperatures greater than 40 °C, the wet bulb temperature must not exceed 39 °C. When operate at low temperatures, the brightness of CCFL will drop and the lifetime of CCFL will be reduced.

Note :

1. V_{dd}=12.0V, f_v=60Hz, f_{CLK}=80 Mhz , 25°C, V_{dd} Duration time= 470 *ms* , Test pattern : white pattern
2. The Backlight power consumption shown above does include loss of external inverter at 25 °C. The used lamp current is the lamp typical current
3. The life is determined as the time at which luminance of the lamp is 50% compared to that of initial value at the typical lamp current on condition of continuous operating at 25 ±2°C.
4. V_{CIM} = 1.2V

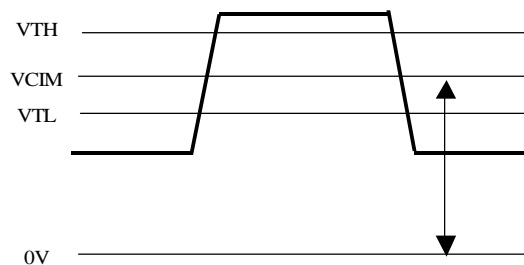
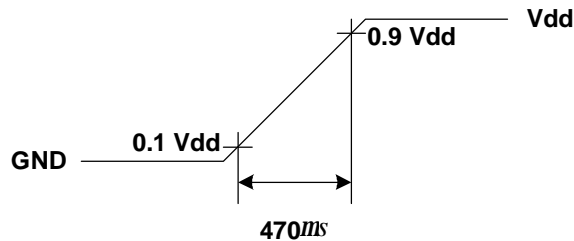

Figure : LVDS Differential Voltage

5. Measurement Condition: Rising time = 470 *μs*





3-2 Interface Connections

- LCD connector: FI-RE51S-HF (JAE) or equivalent

No	Symbol	Description	No	Symbol	Description
1	GND	Ground	27	GND	Ground
2	NC	No connection	28	RE0N	SECOND CHANNEL 0-
3	NC	No connection	29	RE0P	SECOND CHANNEL 0+
4	NC	No connection	30	RE1N	SECOND CHANNEL 1-
5	NC	No connection	31	RE1P	SECOND CHANNEL 1+
6	Reserved		32	RE 2N	SECOND CHANNEL 2-
7	LVDS SEL	LVDS order	33	RE 2P	SECOND CHANNEL 2+
8	Reserved		34	GND	Ground
9	Reserved		35	RECLKN	SECOND CLOCK CHANNEL C-
10	Reserved		36	RECLKP	SECOND CLOCK CHANNEL C+
11	GND	Ground	37	GND	Ground
12	RO 0N	FIRST CHANNEL 0-	38	RE3N	SECOND CHANNEL 3-
13	RO 0P	FIRST CHANNEL 0+	39	RE3P	SECOND CHANNEL 3+
14	RO 1N	FIRST CHANNEL 1-	40	NC	No connection
15	RO 1P	FIRST CHANNEL 1+	41	NC	No connection
16	RO 2N	FIRST CHANNEL 2-	42	GND	Ground
17	RO 2P	FIRST CHANNEL 2+	43	GND	Ground
18	GND	Ground	44	GND	Ground
19	ROCLKN	FIRST CLOCK CHANNEL C-	45	GND	Ground
20	ROCLKP	FIRST CLOCK CHANNEL C+	46	GND	Ground
21	GND	Ground	47	NC	No connection
22	RO 3N	FIRST CHANNEL 3-	48	VLCD	Power Supply +12V
23	RO 3P	FIRST CHANNEL 3+	49	VLCD	Power Supply +12V
24	NC	No connection	50	VLCD	Power Supply +12V
25	NC	No connection	51	VLCD	Power Supply +12V
26	GND	Ground	-	-	-

Note: 1. All GND (ground) pin should be connected together to the LCD module's metal frame.

2. All V_{LCD} (power input) pins should be connected.



LVDS Option = High \Rightarrow JEIDA

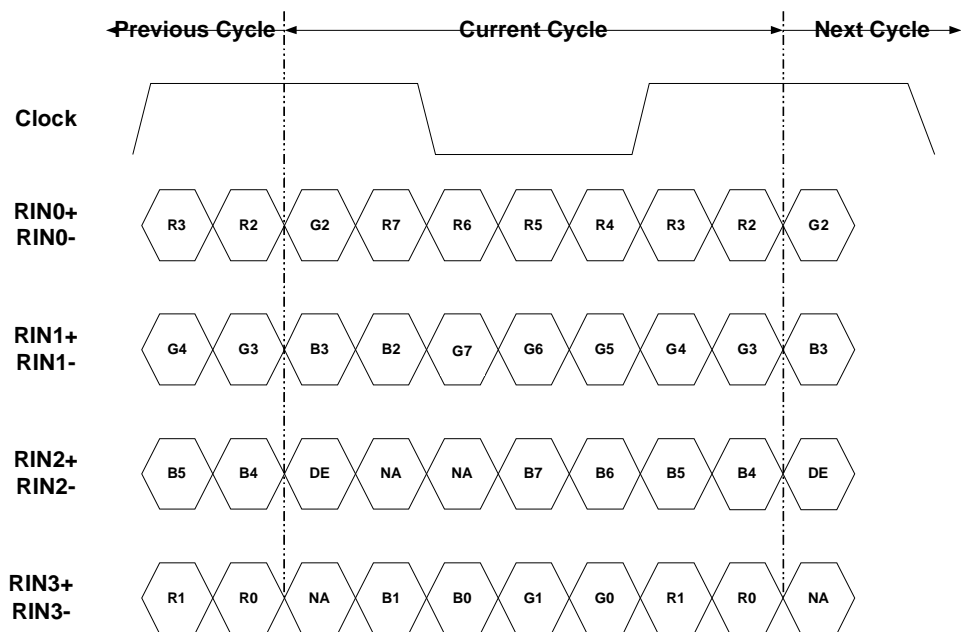

LVDS Option = Low/Open \Rightarrow NS

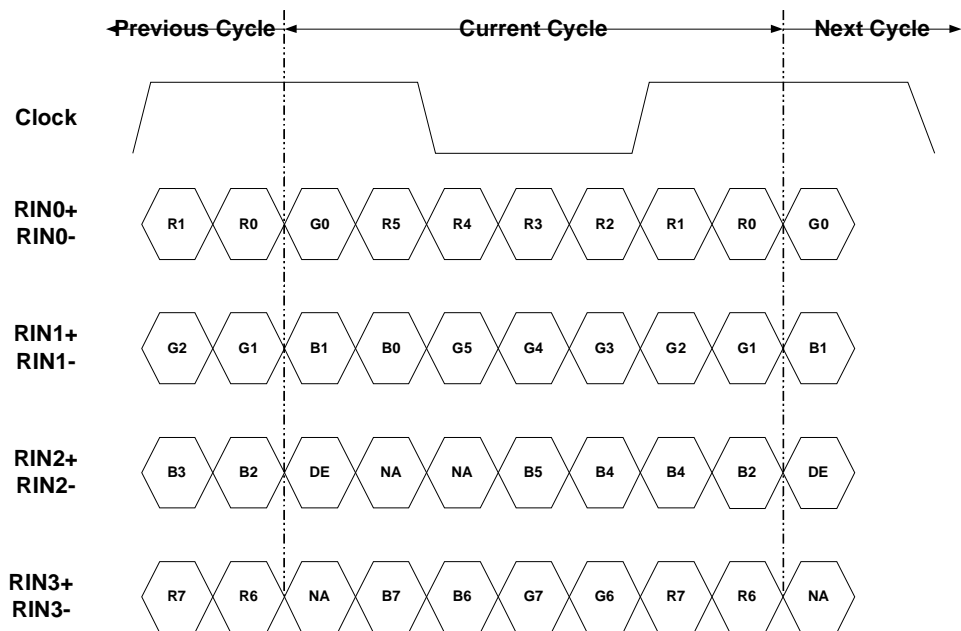



Backlight Connector Pin Configuration

1. Electrical specification

No	ITEM	SYMBOL	CONDITION	MIN	TYP	MAX	UNIT	Note	
1	Input Voltage	V_{DDB}	---	22.8	24.0	26.4	V_{DC}		
2	Input Current	I_{DDB}	$V_{DDB}=24V$ 100% Brightness	6.5	6.8	7.1	A_{DC}	1	
3	Input Power	P_{DDB}	$V_{DDB}=24V$ 100% Brightness	---	(165)	170	W	1	
4	Input inrush current	I_{RUSH}	$V_{DDB}=24V$ 100% Brightness	---	---	12	A_{DC}	2	
5	Output Frequency	F_{BL}	$V_{DDB}=24V$	---	36	---	kHz		
6	ON/OFF Control Voltage	V_{BLON}	ON	$V_{DDB}=24V$	2.0	---	3.3	V_{DC}	
			OFF	$V_{DDB}=24V$	0.0	---	0.8	V_{DC}	
7	ON/OFF Control Current	I_{BLON}	$V_{DDB}=24V$	0	---	2	mA_{DC}		
8	External PWM Control Voltage	$E_{V_{PWM}}$	MAX	---	2.0	---	3.3	V_{DC}	
			MIN	---	0	---	0.8	V_{DC}	
9	External PWM Control Current	$E_{I_{PWM}}$	MAX	PWM=100%	0	---	2	mA_{DC}	
			MIN	PWM=30%	0	---	2	mA_{DC}	
10	External PWM Duty Ratio	$E_{D_{PWM}}$	---	30	---	100	%		
11	External PWM Frequency	$E_{F_{PWM}}$	---	140	180	300	Hz		
12	Internal PWM Control Voltage	$I_{V_{PWM}}$	$V_{DDB}=24V$	0	---	3.3	V_{DC}		

($T_a=25\pm 5^\circ C$, Turn on for 45minutes)

Note 1 : Duration = 20 ms



2. Input specification

Connector 1: S14B-PH-SM3-TB(JST) or equivalent

Pin No	Symbol	Description
1	VDDB	Operating Voltage Supply, +24V DC regulated
2	VDDB	Operating Voltage Supply, +24V DC regulated
3	VDDB	Operating Voltage Supply, +24V DC regulated
4	VDDB	Operating Voltage Supply, +24V DC regulated
5	VDDB	Operating Voltage Supply, +24V DC regulated
6	BLGND	Ground and Current Return
7	BLGND	Ground and Current Return
8	BLGND	Ground and Current Return
9	BLGND	Ground and Current Return
10	BLGND	Ground and Current Return
11	Det(1)	Output of Detect error: Low=NG , High=OK
12	VBLOn	BL On-Off: Open/High (3.3V) for BL On as default
13	PDIM ⁽²⁾	External PWM (AC Signal Control Duty); Internal PWM (DC Power Control Duty, 0~3.3V); Open/High (+3.3V, 100% Duty) for 100%
14	PDIM Selection ^(3,4)	GND: External PWM dimming; Open/High (3.3V): Internal PWM dimming.

Note (1) Det is Output pin for detect power error.

Note (2) PDIM is PWM duty control input for +3.3V TTL level signal or DC voltage by Pin 14 input. This input signal is (a) continuous pulse signal with +3.3V, TTL level signal spec, or (b) DC power with 0~3.3V. If this is Open or +3.3V, 100% duty (i.e. +3.3V, DC level), backlight should perform 100% luminance. Duty ratio of this input signal should be proportional relationship in certain range of control without any kind of inherent side effect like waterfall effect on screen. Guaranteed duty range and dimming ratio should be specified with supplementary measurement result.

Note (3) Pin 14 is the selection pin for PWM control method; if this pin is connected to GND, PDIM input of Pin 13 should have logic level duty signal for PWM control. If this is set to High or Open, Pin 13 should have DC level signal therefore the Inverter should have Saw Tooth Wave Generator to generate internal PWM signal. Default setting is "Not Connected", Pin 13 of PWM control should have DC Level signal for PWM.

Note (4) Pin 14 selection vs. Pin 11/13 control function table:

	Pin 13 Default: Open/High: 100%
Pin 14 = GND	External PWM (AC Signal Control Duty)
Pin 14 = Open/High	Internal PWM (DC Power Control Duty)



Slave Board:

Connector 2: S12B-PH-SM3-TB(JST) or equivalent

Pin No	Symbol	Description
1	VDDB	Operating Voltage Supply, +24V DC regulated
2	VDDB	Operating Voltage Supply, +24V DC regulated
3	VDDB	Operating Voltage Supply, +24V DC regulated
4	VDDB	Operating Voltage Supply, +24V DC regulated
5	VDDB	Operating Voltage Supply, +24V DC regulated
6	BLGND	Ground and Current Return
7	BLGND	Ground and Current Return
8	BLGND	Ground and Current Return
9	BLGND	Ground and Current Return
10	BLGND	Ground and Current Return
11	NC	
12	NC	



3-3 Signal Timing Specifications

This is the signal timing required at the input of the User connector. All of the interface signal timing should be satisfied with the following specifications for it's proper operation.

Timing Table (DE only Mode)

Vertical Frequency Range A (60Hz)

Signal	Item	Symbol	Min	Type	Max	Unit
Vertical Section	Period	Tv	1090	1130	1200	Th
	Active	Tdisp (v)	1080			Th
	Blanking	Tblk (v)	10	50	120	Th
Horizontal Section	Period	Th	1030	1100	1180	Tclk
	Active	Tdisp (h)	960			Tclk
	Blanking	Tblk (h)	70	140	220	Tclk
Clock	Period	CLK		13.41		ns
	Frequency	Freq	67.36	74.58	84.96	MHz
Vertical Frequency	Frequency	Vs	58	60	62	Hz
Horizontal Frequency	Frequency	Hs	65.4	67.8	72	KHz

Vertical Frequency Range B (50Hz)

Signal	Item	Symbol	Min	Type	Max	Unit
Vertical Section	Period	Tv	1316	1356	1426	Th
	Active	Tdisp (v)	1080			Th
	Blanking	Tblk (v)	236	276	346	Th
Horizontal Section	Period	Th	1030	1100	1180	Tclk
	Active	Tdisp (h)	960			Tclk
	Blanking	Tblk (h)	70	140	220	Tclk
Clock	Period	CLK		13.41		ns
	Frequency	Freq	67.77	74.58	84.13	MHz
Vertical Frequency	Frequency	Vs	48	50	52	Hz
Horizontal Frequency	Frequency	Hs	65.8	67.8	71.3	KHz



3-4 Signal Timing Waveforms

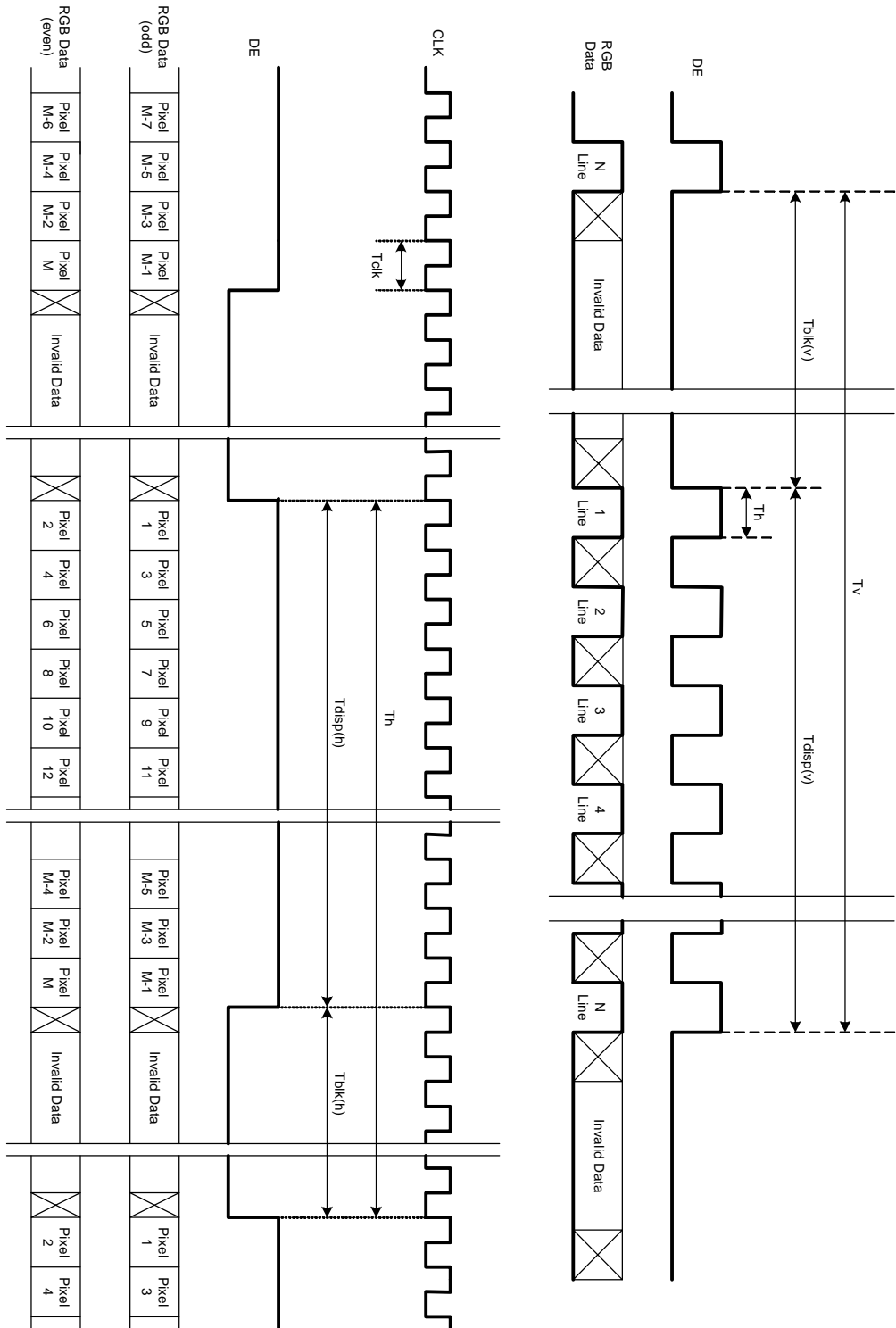



3-5 Color Input Data Reference

The brightness of each primary color (red, green and blue) is based on the 8 bit gray scale data input for the color; the higher the binary input, the brighter the color. The table below provides a reference for color versus data input.

COLOR DATA REFERENCE

Color		Input Color Data																							
		RED								GREEN								BLUE							
		MSB				LSB				MSB				LSB				MSB				LSB			
		R7	R6	R5	R4	R3	R2	R1	R0	G7	G6	G5	G4	G3	G2	G1	G0	B7	B6	B5	B4	B3	B2	B1	B0
Basic Color	Black	0	0	0	0	0	0	0	0	0	0	0	0	0	0	0	0	0	0	0	0	0	0	0	0
	Red(255)	1	1	1	1	1	1	1	1	0	0	0	0	0	0	0	0	0	0	0	0	0	0	0	0
	Green(255)	0	0	0	0	0	0	0	0	1	1	1	1	1	1	1	1	0	0	0	0	0	0	0	0
	Blue(255)	0	0	0	0	0	0	0	0	0	0	0	0	0	0	0	0	1	1	1	1	1	1	1	1
	Cyan	0	0	0	0	0	0	0	0	1	1	1	1	1	1	1	1	1	1	1	1	1	1	1	1
	Magenta	1	1	1	1	1	1	1	1	0	0	0	0	0	0	0	0	1	1	1	1	1	1	1	1
	Yellow	1	1	1	1	1	1	1	1	1	1	1	1	1	1	1	1	0	0	0	0	0	0	0	0
	White	1	1	1	1	1	1	1	1	1	1	1	1	1	1	1	1	1	1	1	1	1	1	1	1
RED	RED(000)	0	0	0	0	0	0	0	0	0	0	0	0	0	0	0	0	0	0	0	0	0	0	0	0
	RED(001)	0	0	0	0	0	0	0	1	0	0	0	0	0	0	0	0	0	0	0	0	0	0	0	0

	RED(254)	1	1	1	1	1	1	1	0	0	0	0	0	0	0	0	0	0	0	0	0	0	0	0	0
	RED(255)	1	1	1	1	1	1	1	1	0	0	0	0	0	0	0	0	0	0	0	0	0	0	0	0
GREEN	GREEN(000)	0	0	0	0	0	0	0	0	0	0	0	0	0	0	0	0	0	0	0	0	0	0	0	0
	GREEN(001)	0	0	0	0	0	0	0	0	0	0	0	0	0	0	0	1	0	0	0	0	0	0	0	0

	GREEN(254)	0	0	0	0	0	0	0	0	1	1	1	1	1	1	1	0	0	0	0	0	0	0	0	0
	GREEN(255)	0	0	0	0	0	0	0	0	1	1	1	1	1	1	1	1	0	0	0	0	0	0	0	0
BLUE	BLUE(000)	0	0	0	0	0	0	0	0	0	0	0	0	0	0	0	0	0	0	0	0	0	0	0	0
	BLUE(001)	0	0	0	0	0	0	0	0	0	0	0	0	0	0	0	0	0	0	0	0	0	0	0	1

	BLUE(254)	0	0	0	0	0	0	0	0	0	0	0	0	0	0	0	0	1	1	1	1	1	1	1	0
	BLUE(255)	0	0	0	0	0	0	0	0	0	0	0	0	0	0	0	0	1	1	1	1	1	1	1	1

3-6 Power Sequence

1. Power sequence of panel

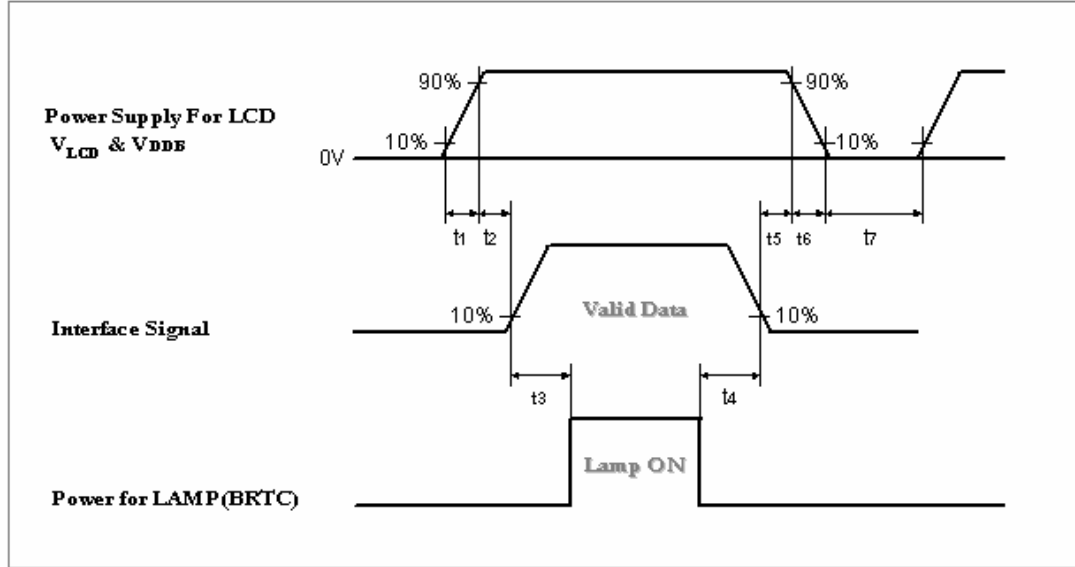

Parameter	Values			Units
	Min.	Typ.	Max.	
t1	470	-	1000	us
t2	20	-	50	ms
t3	500	-	-	ms
t4	200	-	-	ms
t5	50	-	-	ms
t6	0.47	-	30	ms
t7	1	-	-	s

Apply the lamp voltage within the LCD operating range. When the backlight turns on before the LCD operation or the LCD turns off before the backlight turns off, the display may momentarily become abnormal.

Caution : The above on/off sequence should be applied to avoid abnormal function in the display. In case of handling, make sure to turn off the power when you plug the cable into the input connector or pull the cable out of the connector.



2. Power sequence of inverter

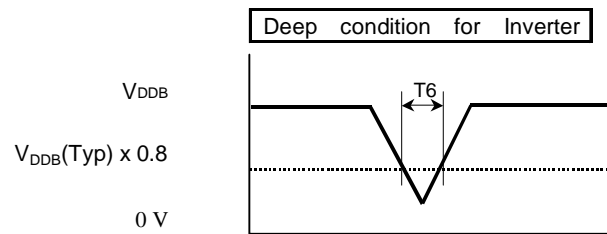
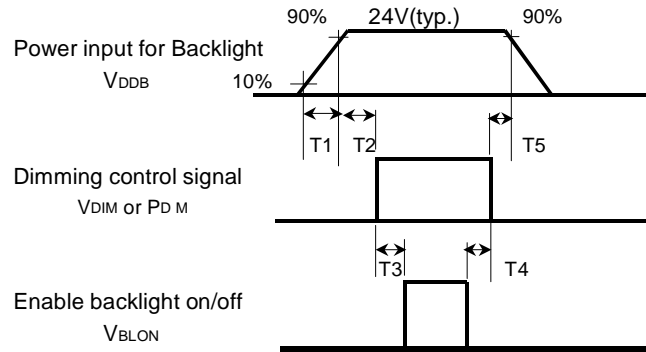

Parameter	Values			Units
	Min.	Typ.	Max.	
T1	20	-	-	ms
T2	500	-	-	ms
T3	250	-	-	ms
T4	0	-	-	ms
T5	1	-	-	ms
T6	-	-	10	ms



4. Optical Specification

Optical characteristics are determined after the unit has been 'ON' and stable for approximately 60 minutes in a dark environment at 25°C. The values specified are at an approximate distance 50cm from the LCD surface at a viewing angle of Φ and θ equal to 0°.

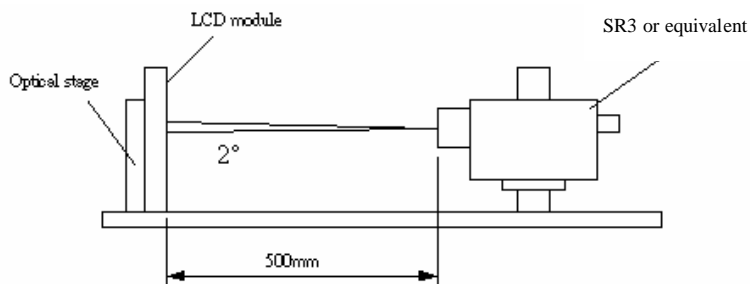

Fig.4-1 Optical measurement equipment and method

Parameter	Symbol	Values			Units	Notes
		Min.	Typ.	Max.		
Contrast Ratio	CR	1000	1500			1
Surface Luminance, white	LWH	400	500		cd/m ²	2
Luminance Variation	δ_{WHITE}	5p		1.3		3
Response Time (Average)	T_{γ}		8		ms	4,5 (Gray to Gray)
	Rise Time	T_r	15		ms	4
	Decay Time	T_f	5		ms	4
Color Coordinates						
	RED	R_x		0.640		
		R_y		0.330		
	GREEN	G_x		0.290		
		G_y	Typ.-0.03	0.600	Typ.+0.03	
	BLUE	B_x		0.150		
		B_y		0.060		
	WHITE	W_x		0.280		
		W_y		0.290		
Viewing Angle						
	x axis, right($\varphi=0^\circ$)	θ_r		89	Degree	6
	x axis, left($\varphi=180^\circ$)	θ_l		89		
	y axis, up($\varphi=90^\circ$)	θ_u		89		
	y axis, down($\varphi=0^\circ$)	θ_d		89		

Note:

1. Contrast Ratio (CR) is defined mathematically as:

$$\text{Contrast ratio (CR)} = \frac{\text{Brightness on the "white" state}}{\text{Brightness on the "black" state}}$$

2. Surface luminance is luminance value at point 1 across the LCD surface 50cm from the surface with all pixels displaying white. From more information see Fig. 4-2. When $V_{DDB} = 24V$, $I_{DDB} = 6.4A$. $L_{WH} = L_{on1}$, Where L_{on1} is the luminance with all pixels displaying white at center 1 location.

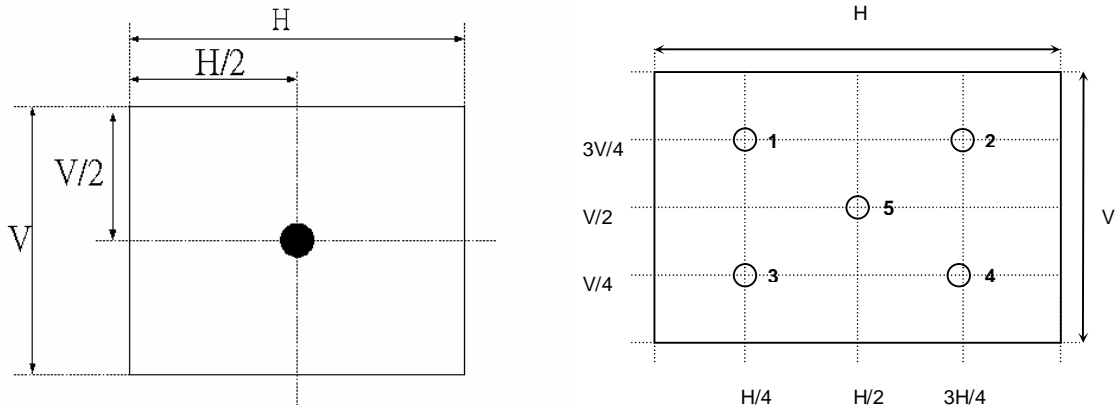

Fig.4-2 Optical measurement point

3. The variation in surface luminance, δ_{WHITE} is defined under 100% brightness as:

$$\delta_{WHITE(5P)} = \frac{\text{Maximum}(L_{on1}, L_{on2}, \dots, L_{on5})}{\text{Minimum}(L_{on1}, L_{on2}, \dots, L_{on5})}$$

4. Response time is the time required for the display to transition from white(L255) to black(L0) (Decay Time, $Tr_D = Tf$) and from black(L0) to white(L255) (Rise Time, $Tr_R = Tr$). For additional information see Fig. 4-3.

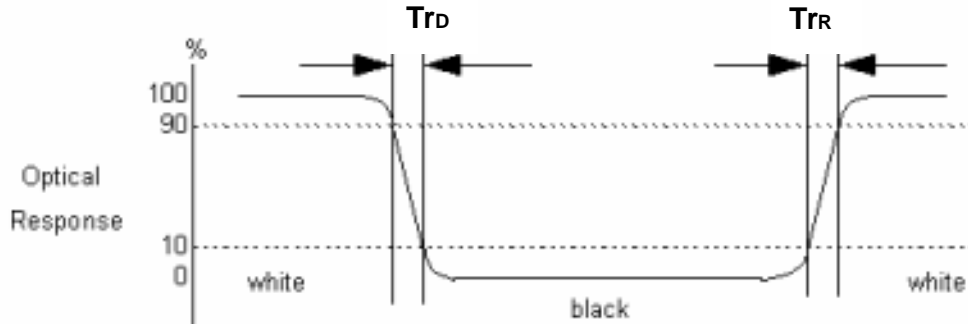

Fig.4-3 Response time

5. The response time is defined as the following figure and shall be measured by switching the input signal for 0, 63, 127, 191, 255 different gray level. For additional information see Fig. 4-4.

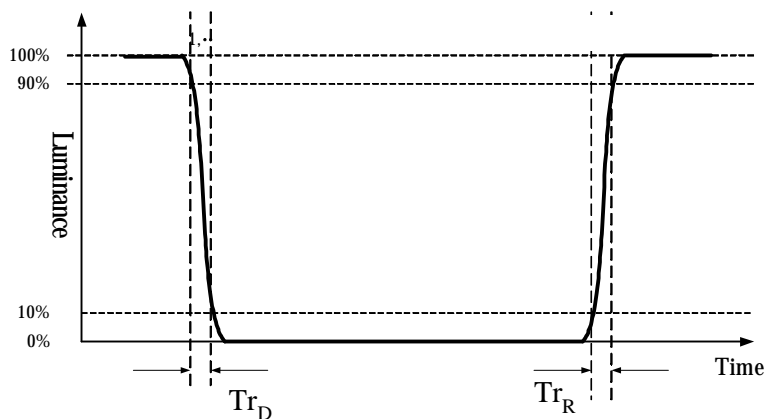

Fig.4-4 Response time

6. Viewing angle is the angle at which the contrast ratio is greater than 10. The angles are determined for the horizontal or x axis and the vertical or y axis with respect to the z axis which is normal to the LCD surface. For more information see Fig. 4-5. (Optical measurement by SR3)

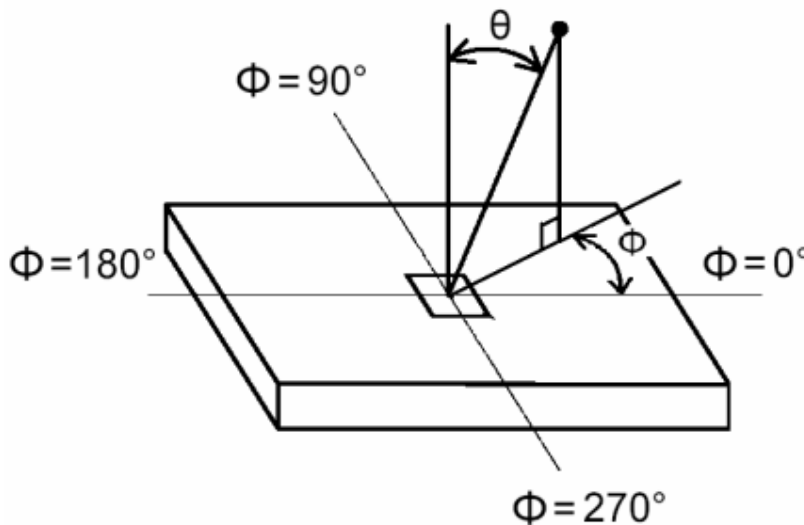

Fig.4-5 Viewing Angle Definition



5. Mechanical Characteristics

The contents provide general mechanical characteristics for the model T420HW01. In addition the figures in the next page are detailed mechanical drawing of the LCD.

Outline Dimension	Horizontal (typ.)	983.0mm
	Vertical (typ.)	576.0mm
	Depth (typ.)	52.3mm (with inverter)
Bezel Area	Horizontal (typ.)	939.0mm
	Vertical (typ.)	531.26mm
Active Display Area	Horizontal	930.25mm
	Vertical	523.26mm
Weight	12600g (typ.) 13600g (Max.)	
Surface Treatment	AG, 3H	



2D drawing

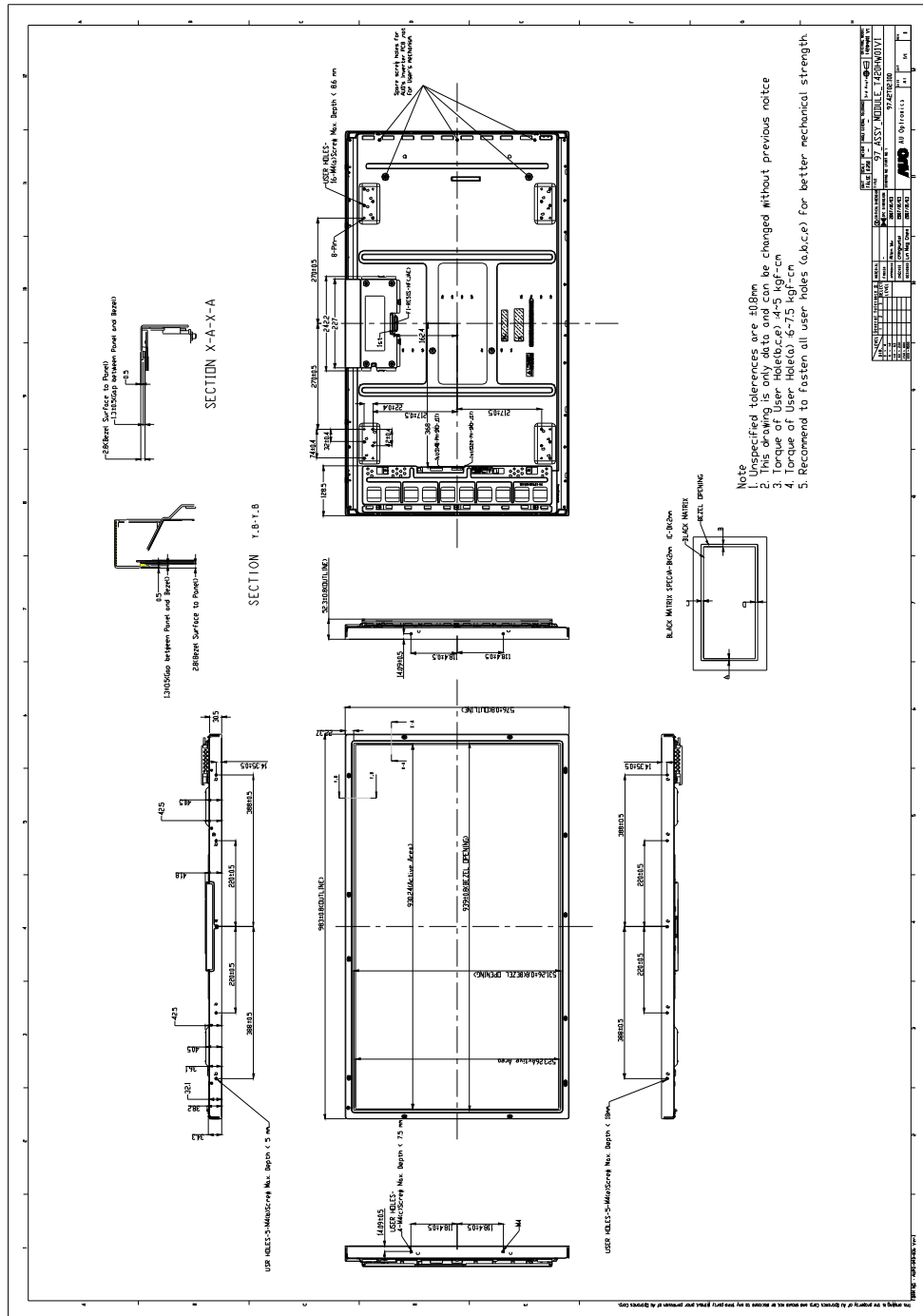



6. Reliability

Environment test condition

No	Test Item	Condition
1	High temperature storage test	Ta=60°C, 300hr judge
2	Low temperature storage test	Ta=-20°C, 300h judge
3	High temperature/High humidity test	Ta=50°C, 80%RH, 300hr judge
4	High temperature operation test	Ta=50°C, 300hr judge
5	Low temperature operation test	Ta=-5°C, 300hr judge
6	Vibration test (non-operating)	Wave form: SIN Vibration level: 1.5G RMS Bandwidth: 10-500Hz Duration: X, Y, Z 30min each direction
7	Shock test (non-operating)	Shock level: 50G Waveform: half sine wave, 11ms Direction: ±X, ±Y, ±Z One time each direction
8	Vibration test (with carton)	Wave form: Random Vibration level: 2.16G RMS Bandwidth: 5~500Hz Duration: X, Y, Z 120min each direction
9	Drop test (with carton)	Height: 46cm 1 corner, 3 edges, 6 surfaces (ASTMD4169-I)



7. International Standard

7-1. Safety

- (1) UL60065, Underwriters Laboratories, Inc. (AUO file number : E204356)
Standard for Safety of Information Technology Equipment Including electrical Business Equipment.
- (2) CSA E60065, Canadian Standards Association
Standard for Safety of Information Technology Equipment Including Electrical Business Equipment.
- (3) IEC 60065 ver. 7th, European Committee for Electro technical Standardization (CENELEC)
EUROPEAN STANDARD for Safety of Information Technology Equipment Including Electrical Business Equipment.

7-2. EMC

- (1) ANSI C63.4 "Methods of Measurement of Radio-Noise Emissions from Low-Voltage Electrical and Electrical Equipment in the Range of 9kHz to 40GHz. "American National standards Institute(ANSI), 1992
- (2) C.I.S.P.R "Limits and Methods of Measurement of Radio Interface Characteristics of Information Technology Equipment." International Special committee on Radio Interference.
- (3) EN 55022 "Limits and Methods of Measurement of Radio Interface Characteristics of Information Technology Equipment." European Committee for Electrotechnical Standardization. (CENELEC), 1998



(2) Packing

Packing Instruction

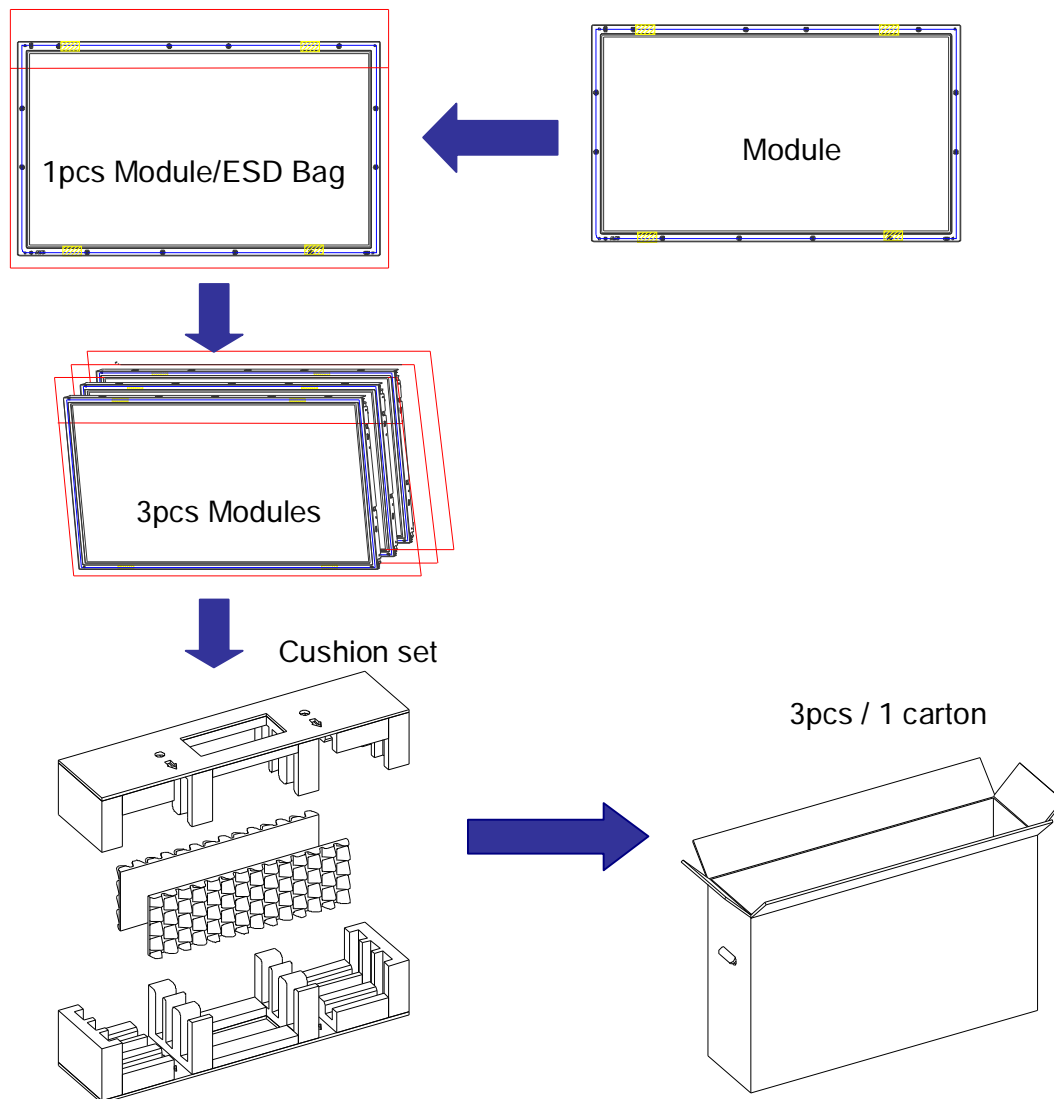

Package information:

Carton outside dimension : 1087x285x716mm

Carton/Package weight : 3kg



Shipping label



Green Mark Description:

For Pb Free products, AUO will add  for identification.

For RoHS compatible products, AUO will add  for identification.

Note: The Green Mark will be present only when the green documents have been ready by AUO Internal Green Team. (The definition of green design follows the AUO green design checklist.)

Carton label

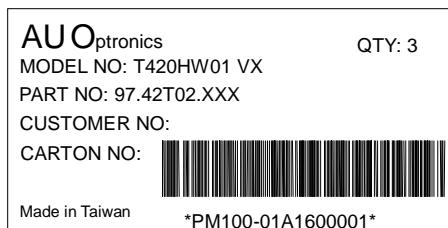

Pallet information

By air cargo : (4x1) x2 layers, one pallet put 8 boxes, total 24 pcs module.

By sea : (4x1) x3 layers, one pallet put 12 boxes, total 36 pcs module.

Pallet dimension : 1150x1100x120mm

Pallet weight : 10kg

By air total weight : 40.8 kg/box X 8 boxes=326.4 kg (with pallet weight 336.4kg)

By sea total weight : 40.8 kg/box X 12 boxes=489.6 kg (with pallet weight 499.6kg)

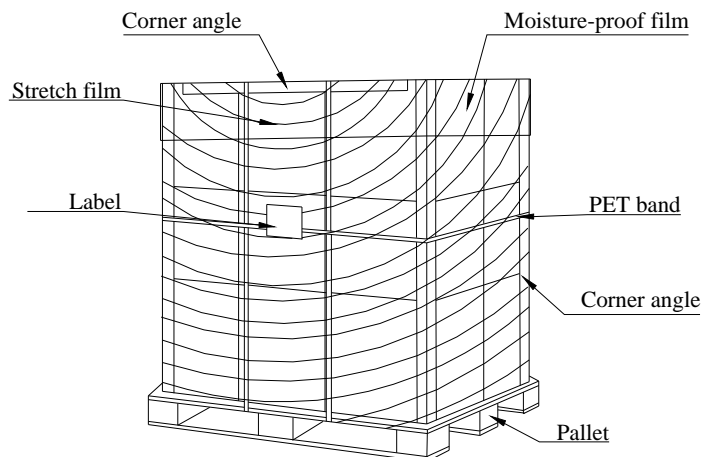



(3) PRECAUTIONS

Please pay attention to the followings when you use this TFT LCD module.

9-1 MOUNTING PRECAUTIONS

- (1) You must mount a module using holes arranged on back side of panel.
- (2) Please attach the surface transparent protective plate to the surface in order to protect the polarizer. Transparent protective plate should have sufficient strength in order to resist external force.
- (3) You should adopt radiation structure to satisfy the temperature specification.
- (4) Acetic acid type and chlorine type materials for the cover case are not desirable because the former generates corrosive gas of attacking the polarizer at high temperature and the latter causes circuit break by electro-chemical reaction.
- (5) Do not touch, push or rub the exposed polarizers with glass, tweezers or anything harder than HB pencil lead. And please do not rub with dust clothes with chemical treatment. Do not touch the surface of polarizer for bare hand or greasy cloth. (Some cosmetics are detrimental to the polarizer.)
- (6) When the surface becomes dusty, please wipe gently with absorbent cotton or other soft materials like chamois soaked with petroleum benzene. Normal-hexane is recommended for cleaning the adhesives used to attach front/ rear polarizers. Do not use acetone, toluene and alcohol because they cause chemical damage to the polarizer.
- (7) Wipe off saliva or water drops as soon as possible. Their long time contact with polarizer causes deformations and color fading.
- (8) Do not open the case because inside circuits do not have sufficient strength.

9-2 OPERATING PRECAUTIONS

- (1) The spike noise causes the mis-operation of circuits. It should be lower than following voltage:
 $V = \pm 200\text{mV}$ (Over and under shoot voltage)
- (2) Response time depends on the temperature. (In lower temperature, it becomes longer..)
- (3) Brightness depends on the temperature. (In lower temperature, it becomes lower.) And in lower temperature, response time (required time that brightness is stable after turned on) becomes longer.
- (4) Be careful for condensation at sudden temperature change. Condensation makes damage to polarizer or electrical contacted parts. And after fading condensation, smear or spot will occur.
- (5) When fixed patterns are displayed for a long time, remnant image is likely to occur.
- (6) Module has high frequency circuits. Sufficient suppression to the electromagnetic interference



shall be done by system manufacturers. Grounding and shielding methods may be important to minimize the interface.

9-3 ELECTROSTATIC DISCHARGE CONTROL

Since a module is composed of electronic circuits, it is not strong to electrostatic discharge. Make certain that treatment persons are connected to ground through wrist band etc. And don't touch interface pin directly.

9-4 PRECAUTIONS FOR STRONG LIGHT EXPOSURE

Strong light exposure causes degradation of polarizer and color filter.

9-5 STORAGE

When storing modules as spares for a long time, the following precautions are necessary.

- (1) Store them in a dark place. Do not expose the module to sunlight or fluorescent light. Keep the temperature between 5°C and 35°C at normal humidity.
- (2) The polarizer surface should not come in contact with any other object. It is recommended that they be stored in the container in which they were shipped.

9-6 HANDLING PRECAUTIONS FOR PROTECTION FILM

- (1) The protection film is attached to the bezel with a small masking tape. When the protection film is peeled off, static electricity is generated between the film and polarizer. This should be peeled off slowly and carefully by people who are electrically grounded and with well ion-blown equipment or in such a condition, etc.
- (2) When the module with protection film attached is stored for a long time, sometimes there remains a very small amount of glue still on the bezel after the protection film is peeled off.
- (3) You can remove the glue easily. When the glue remains on the bezel or its vestige is recognized, please wipe them off with absorbent cotton waste or other soft material like chamois soaked with normal-hexane.