



This Datasheet has been downloaded from:

DisplayAlliance.com

Please call +1 (978) 465-6190 or email sales@massintegrated.com for a quote.



[ISO 9001 : 2008](#)

SAMSUNG

ELECTRONICS

Product Information



Product Information

SAMSUNG TFT-LCD

MODEL NO. : LTN141W1-L04

LCD Product Planning Group 1, Marketing Team

Samsung Electronics Co . , LTD.



SAMSUNG TFT-LCD

Doc.No.	LTN141W1-L04	ISSUED DATE	03/Mar/2006	Page	1 / 13
----------------	--------------	--------------------	-------------	-------------	--------

CONTENTS

General Description	----- (4)
1. Electrical Absolute Ratings	----- (4)
2. Optical Characteristics	----- (5)
3. Electrical Characteristics	----- (6)
3.1 TFT LCD Module	
3.2 Backlight Unit	
4. Block Diagram	----- (7)
4.1 TFT LCD Module	
4.2 Backlight Unit	
5. Input Terminal Pin Assignment	----- (8)
5.1 Input Signal & Power	
5.2 Backlight Unit	
5.3 Timing Diagrams of LVDS For Transmitting	
6. Interface Timing	----- (10)
6.1 Timing Parameters	
6.2 Timing Diagrams of interface Signal	
6.3 Power ON/OFF Sequence	
7. Outline Dimension	----- (12)

GENERAL DESCRIPTION

DESCRIPTION

LTN141W1-L04 is a color active matrix TFT (Thin Film Transistor) liquid crystal display (LCD) that uses amorphous silicon TFT as a switching devices. This model is composed of a TFT LCD panel, a driver circuit and a backlight unit. The resolution of a 14.1" contains 1280 x 800 pixels and can display up to 262,144 colors. 6 O'clock direction is the Optimum viewing angle.

FEATURES

- High contrast ratio, high aperture structure
- WXGA (1280 x 800 pixels) resolution
- Low power consumption
- Fast Response
- Single CCFL
- DE(Data enable) only mode
- 3.3V LVDS Interface
- Onboard EEDID chip
- Pb-free product

APPLICATIONS

- Notebook PC
- If the usage of this product is not for PC application, but for others, please contact SEC

GENERAL INFORMATION

Item	Specification	Unit	Note
Display area	303.36(H) x 189.6(V) (14.1" diagonal)	mm	
Driver element	a-Si TFT active matrix		
Display colors	262,144		
Number of pixel	1280 x 800	pixel	
Pixel arrangement	RGB vertical stripe		
Pixel pitch	0.2370(H) x 0.2370(V) (TYP.)	mm	
Display Mode	Normally white		
Surface treatment	Haze 0(Glare), Haze 25(Anti-Glare), Hard-Coating 3H		

MECHANICAL INFORMATION

Item		Min.	Typ.	Max.	Unit	Note
Module size	Horizontal (H)	319.0	319.5	320.0	mm	
	Vertical (V)	205.0	205.5	206.0	mm	
	Depth (D)	-	5.2	5.5	mm	(1)
Weight		-	390	400	g	

Note (1) Measurement condition of outline dimension
. Equipment : Bernier Calipers
. Push Force : 500g · f (minimum)

1. ELECTRICAL ABSOLUTE RATINGS**(1) TFT LCD MODULE**
 $V_{DD} = 3.3V, V_{SS} = GND = 0V$

Item	Symbol	Min.	Max.	Unit	Note
Power Supply Voltage	V_{DD}	$V_{DD} - 0.3$	$V_{DD} + 0.3$	V	(1)
Logic Input Voltage	V_{IN}	$V_{DD} - 0.3$	$V_{DD} + 0.3$	V	(1)

Note (1) Within T_a ($25 \pm 2 \text{ }^\circ\text{C}$)

(2) BACK-LIGHT UNIT
 $T_a = 25 \pm 2 \text{ }^\circ\text{C}$

Item	Symbol	Min.	Max.	Unit	Note
Lamp Current	I_L	3.0	7.0	mArms	(1)
Lamp frequency	F_L	40	80	kHz	(1)

Note 1) Permanent damage to the device may occur if maximum values are exceeded
Functional operation should be restricted to the conditions described under normal operating conditions.

2. OPTICAL CHARACTERISTICS

The following items are measured under stable conditions. The optical characteristics should be measured in a dark room or equivalent state.

Measuring equipment : TOPCON BM-5A and PR-650

* Ta = 25 ± 2 °C, VDD=3.3V, fv= 60Hz, fdCLK = 68.9MHz, IL = 6.0 mA

Item	Symbol	Condition	Min.	Typ.	Max	Unit	
Contrast Ratio (5 Points)	CR		(300)	-	-	-	
Response Time at Ta (Rising + Falling)	T _{RT}		-	25	35	msec	
Average Luminance of White (5 Points)	Y _{L,AVE}		(170)	(200)	-	cd/m ²	
Color Chromaticity (CIE)	Red	R _X	Normal Viewing Angle φ = 0 θ = 0	-	TBD	-	-
		R _Y		-	TBD	-	
	Green	G _X		-	TBD	-	
		G _Y		-	TBD	-	
	Blue	B _X		-	TBD	-	
		B _Y		-	TBD	-	
	White	W _X		(0.283)	(0.313)	(0.343)	
		W _Y		(0.299)	(0.329)	(0.359)	
Viewing Angle	Hor.	θ _L	CR ≥ 10 At center	40	45		Degrees
		θ _H		40	45		
	Ver.	φ _H		10	15		
		φ _L		25	30		
13 Points White Variation	δ _L		-	-	(2.2)	-	

3. ELECTRICAL CHARACTERISTICS

3.1 TFT LCD MODULE

Ta= 25 ± 2°C

Item	Symbol	Min.	Typ.	Max.	Unit	Note	
Voltage of Power Supply	V _{DD}	3.0	3.3	3.6	V		
Differential Input Voltage for LVDS Receiver Threshold	High	V _{IH}	-	-	+100	mV	V _{CM} = +1.2V
	Low	V _{IL}	-100	-	-	mV	
Vsync Frequency	f _v	-	60	-	Hz		
Hsync Frequency	f _H	-	48.96	-	KHz		
Main Frequency	f _{DCLK}	-	68.9	-	MHz		
Rush Current	I _{RUSH}	-	-	1.5	A		
Current of Power Supply	White	I _{DD}	-	TBD	-	mA	
	Mosaic		-	TBD	-	mA	
	V. stripe		-	TBD	(500)	mA	

3.2 BACK-LIGHT UNIT

The backlight system is an edge-lighting type with a single CCFT (Cold Cathode Fluorescent Tube).
The characteristics of a single lamp are shown in the following table.

- INVERTER : SEM SIC 130T

Ta= 25 ± 2 °C

Item	Symbol	Min.	Typ.	Max.	Unit	Note
Lamp Current	I _L	3.0	6.0	6.5	mArms	
Lamp Voltage	V _L	-	TBD	-	Vrms	I _L = 6.0mA
Frequency	f _L	50	60	65	KHz	
Power Consumption	P _L		TBD		W	I _L = 6.0mA
Operating Life Time	Hr	10,000			Hour	
Startup Voltage	V _s			(1120)	Vrms	25°C
				(1345)	Vrms	0°C
Lamp Start-up time	T _s	-	-	1.0	sec	

4. BLOCK DIAGRAM

4.1 TFT LCD Module

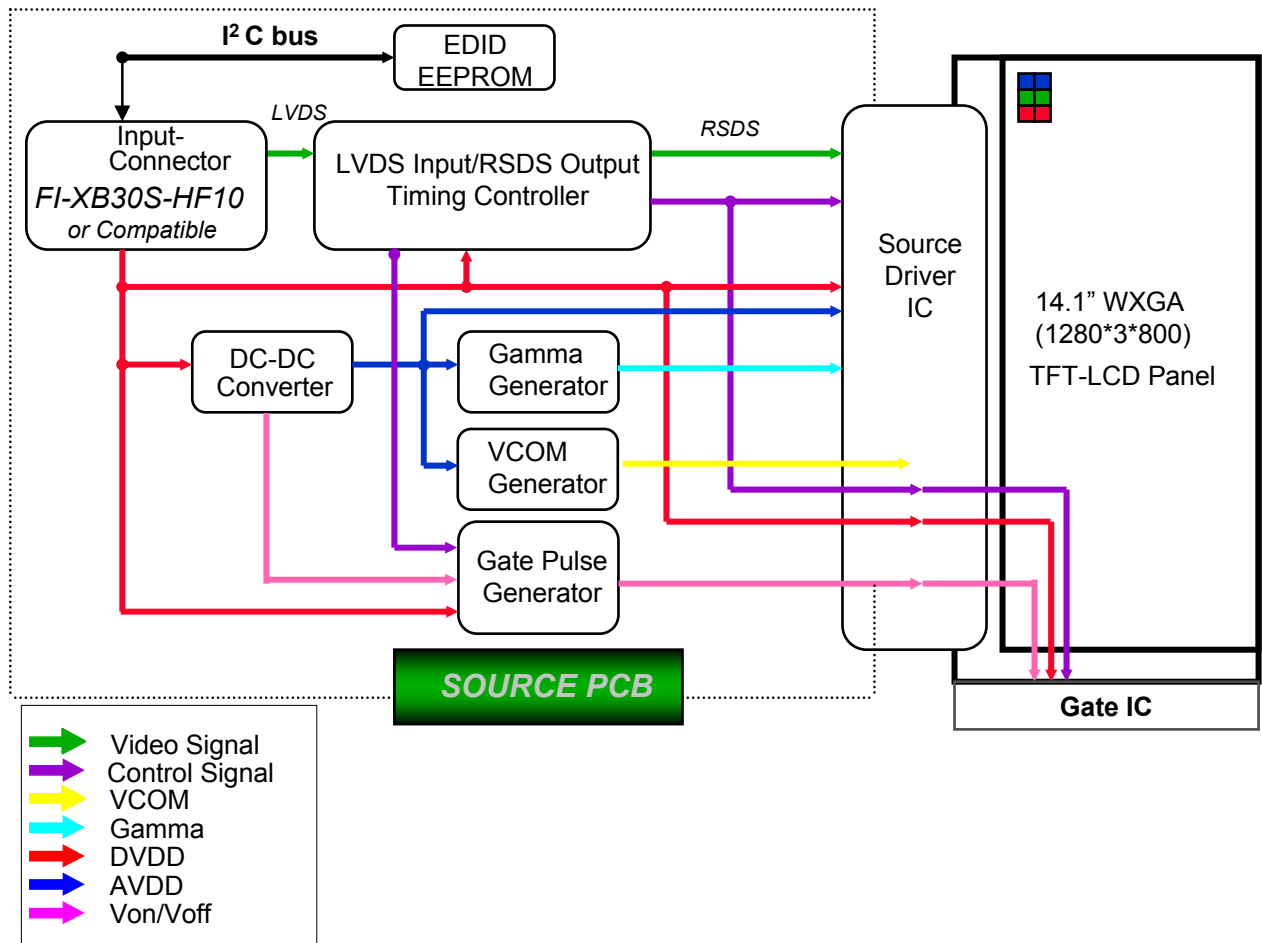

4.2 BACKLIGHT UNIT

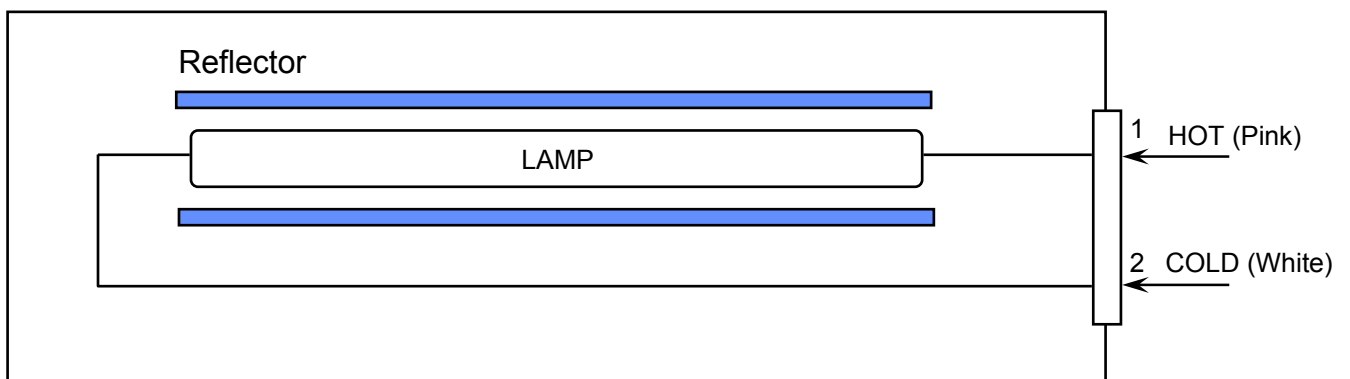

Note) The output of the inverter may change according to the material of the reflector.

5. INPUT TERMINAL PIN ASSIGNMENT

5.1. Input Signal & Power LVDS, Connector : (JAE, FI-XB30S-HF10 or Compatible)
Mating Connector :(JAE FI-X30M or Compatible)

No.	Symbol	Function	Polarity	Remarks
1	VSS	Ground		
2	VDD	POWER SUPPLY +3.3V		
3	VDD	POWER SUPPLY +3.3V		
4	VEEDID	DDC 3.3V Power		
5	NC	No connect		
6	CLKEDID	DDC Clock		
7	DATAEDID	DDC data		
8	RxIN0-	LVDS Differential Data INPUT (R0-R5,G0)	Negative	
9	RxIN0+	LVDS Differential Data INPUT (R0-R5,G0)	Positive	
10	GND	Ground		
11	RxIN1-	LVDS Differential Data INPUT (G1-G5,B0-B1)	Negative	
12	RxIN1+	LVDS Differential Data INPUT (G1-G5,B0-B1)	Positive	
13	GND	Ground		
14	RxIN2-	LVDS Differential Data INPUT (B2-B5,Sync,DE)	Negative	
15	RxIN2+	LVDS Differential Data INPUT (B2-B5,Sync,DE)	Positive	
16	Vss	Ground		
17	ClkIN-	LVDS Differential Clock INPUT	Negative	
18	ClkIN+	LVDS Differential Clock INPUT	Positive	
19	Vss	Ground		
20	NC	No connect		
21	NC	No connect		
22	NC	No connect		
23	NC	No connect		
24	NC	No connect		
25	NC	No connect		
26	NC	No connect		
27	NC	No connect		
28	NC	No connect		
29	NC	No connect		
30	NC	No connect		

5.2 BACK LIGHT UNIT

Connector : JST BHSR - 02VS -1
 Mating Connector : SM02B-BHSS-1(JST)

Pin NO.	Symbol	Color	Function
1	HOT	Pink	High Voltage
2	COLD	White	Low Voltage

5.3 Timing Diagrams of LVDS For Transmission

LVDS Receiver : Integrated T-CON

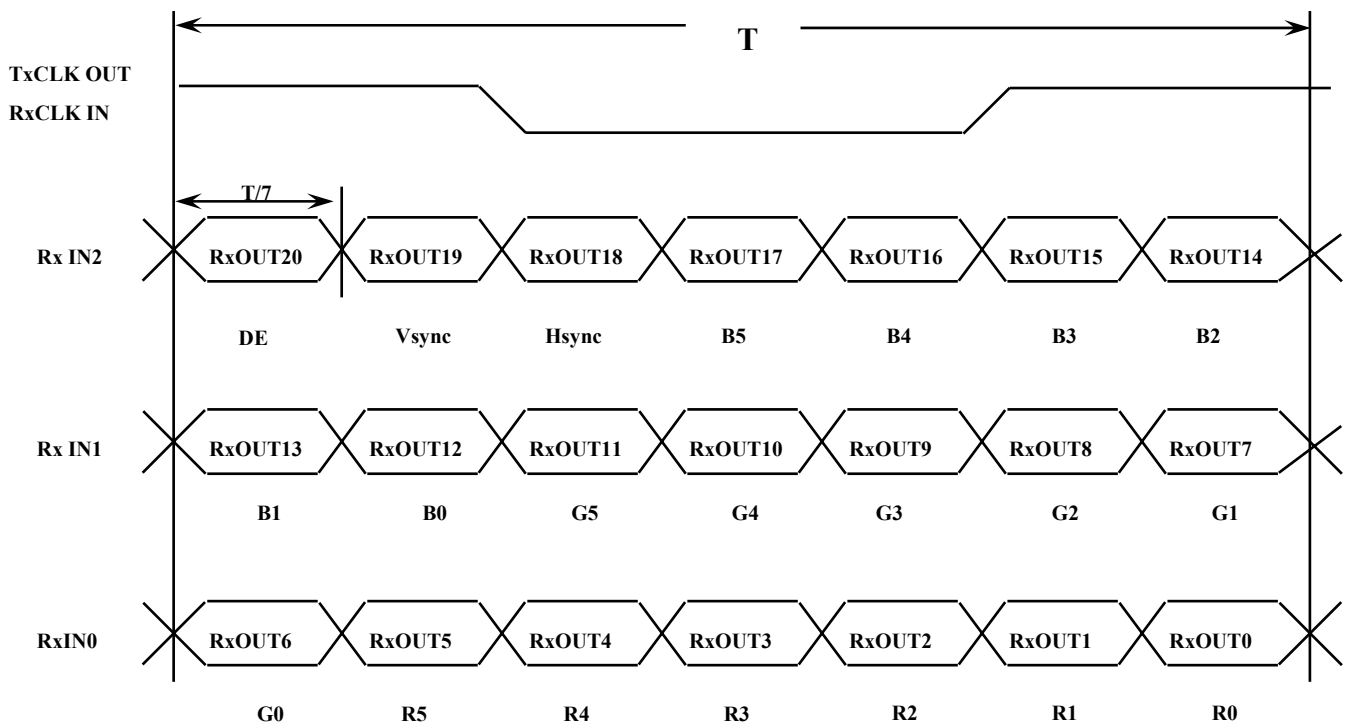

6. INTERFACE TIMING

6.1 Timing Parameters

Signal	Item	Symbol	Min.	Typ.	Max.	Unit	Note
Frame Frequency	Cycle	TV	804	816	1000	Lines	
Vertical Active Display Term	Display Period	TVD	-	800	-	Lines	
One Line Scanning Time	Cycle	TH	1316	1408	1500	Clocks	
Horizontal Active Display Term	Display Period	THD	-	1280	-	Clocks	

6.2 Timing diagrams of interface signal

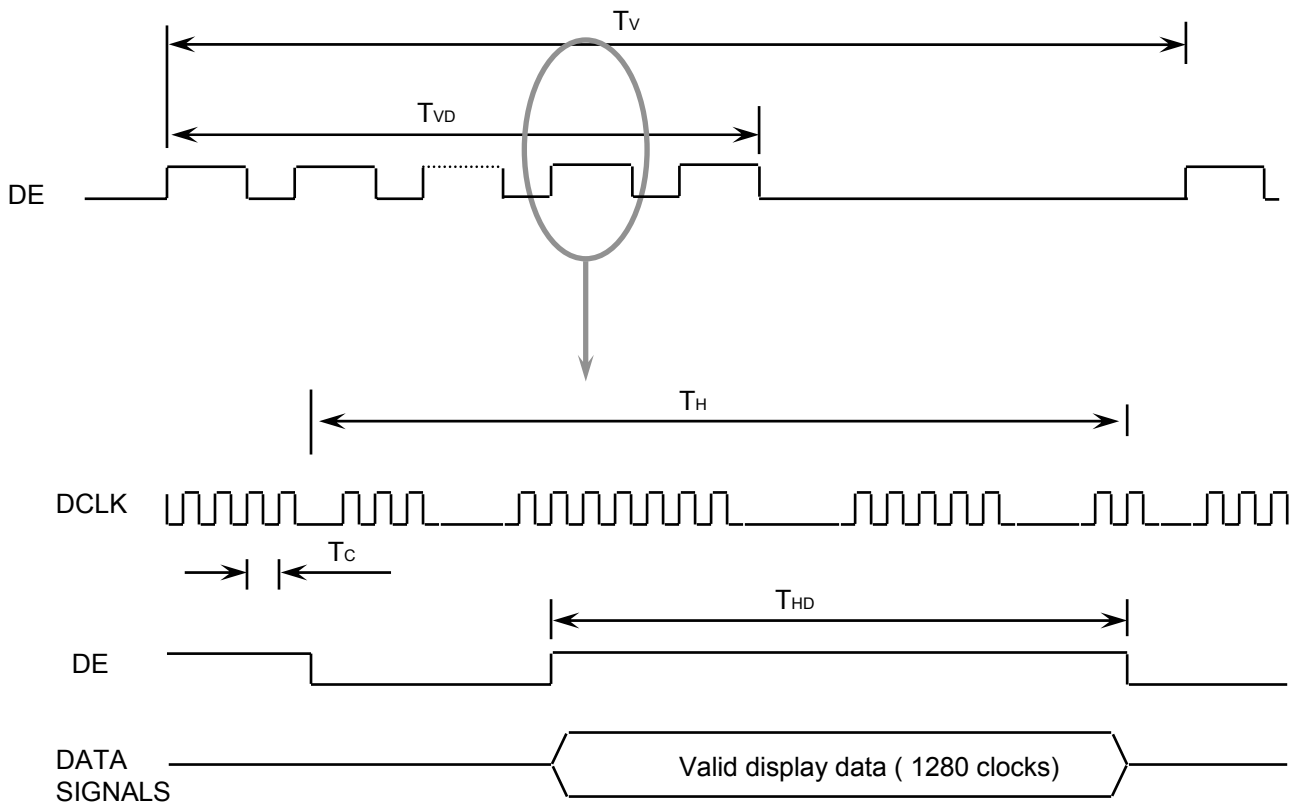

6.3 Power ON/OFF Sequence

: To prevent a latch-up or DC operation of the LCD module, the power on/off sequence should be as the diagram below.

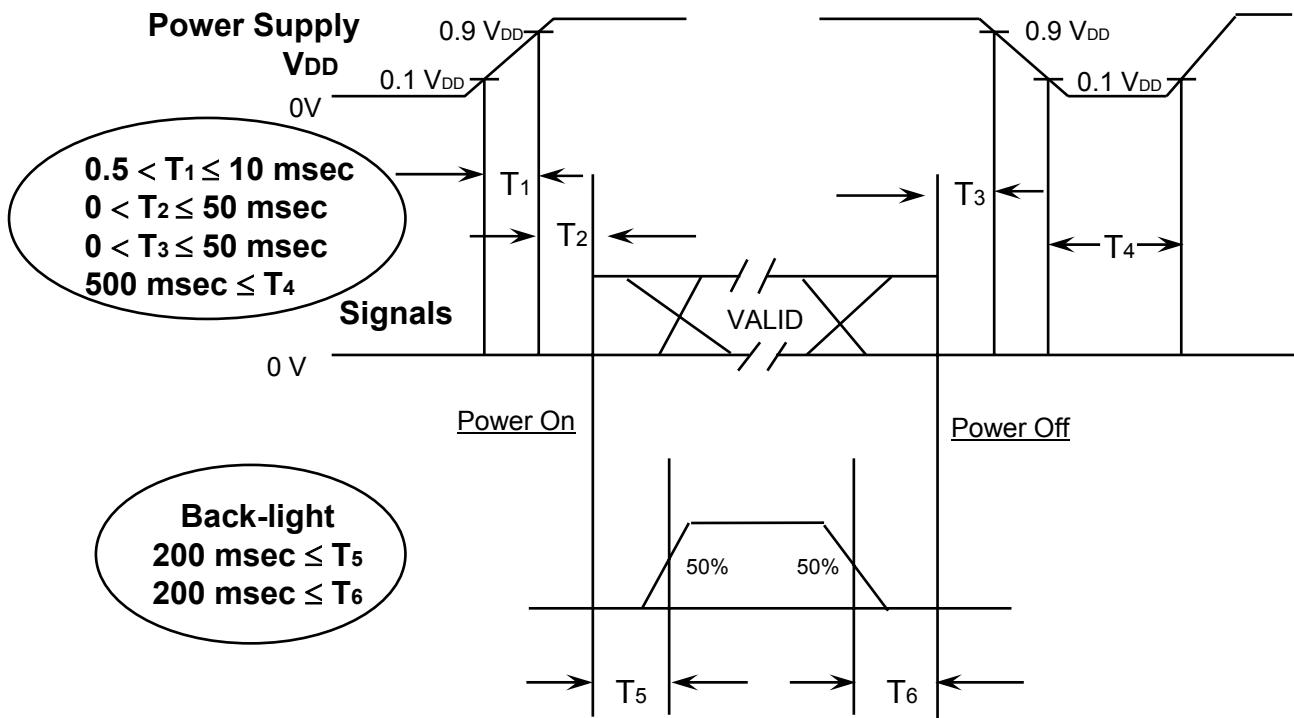

Power ON/OFF Sequence

- T1 : Vdd rising time from 10% to 90%
- T2 : The time from Vdd to valid data at power ON.
- T3 : The time from valid data off to Vdd off at power Off.
- T4 : Vdd off time for Windows restart
- T5 : The time from valid data to B/L enable at power ON.
- T6 : The time from valid data off to B/L disable at power Off.

NOTE.

- (1) The supply voltage of the external system for the module input should be the same as the definition of VDD.
- (2) Apply the lamp voltage within the LCD operation range. When the back-light turns on before the LCD operation or the LCD turns off before the back-light turns off, the display may momentarily become white.
- (3) In case of VDD = off level, please keep the level of input signals on the low or keep a high impedance.
- (4) T4 should be measured after the module has been fully discharged between power off and on period.
- (5) Interface signal shall not be kept at high impedance when the power is on.

7. MECHANICAL OUTLINE DIMENSION

Product Information

[Refer to the next page]

Doc.No.	LTN141W1-L04	ISSUED DATE	03/Mar/2006	Page	12 / 13
----------------	--------------	--------------------	-------------	-------------	---------

NO	PART NAME	CODE NO	SPECIFICATION	Q'TY	WEIGHT FINISH	MATERIAL	INFORMED DIM. OF MATERIAL	REMARK
1	LTN141W1-L04	-		1EA				

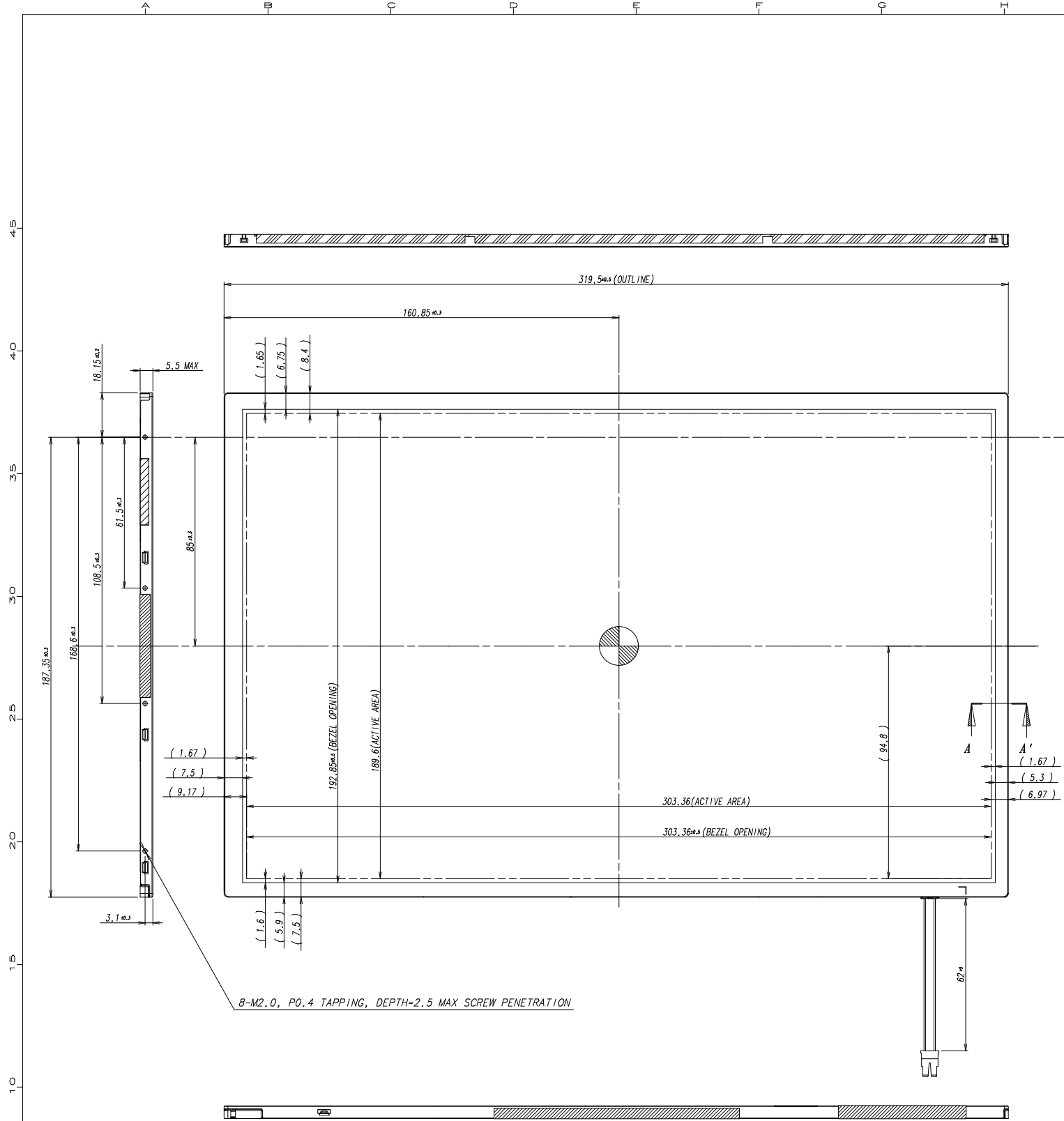

SCREW PENETRATION DEPTH

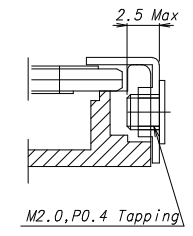

SECTION A-A' (S=5/1)

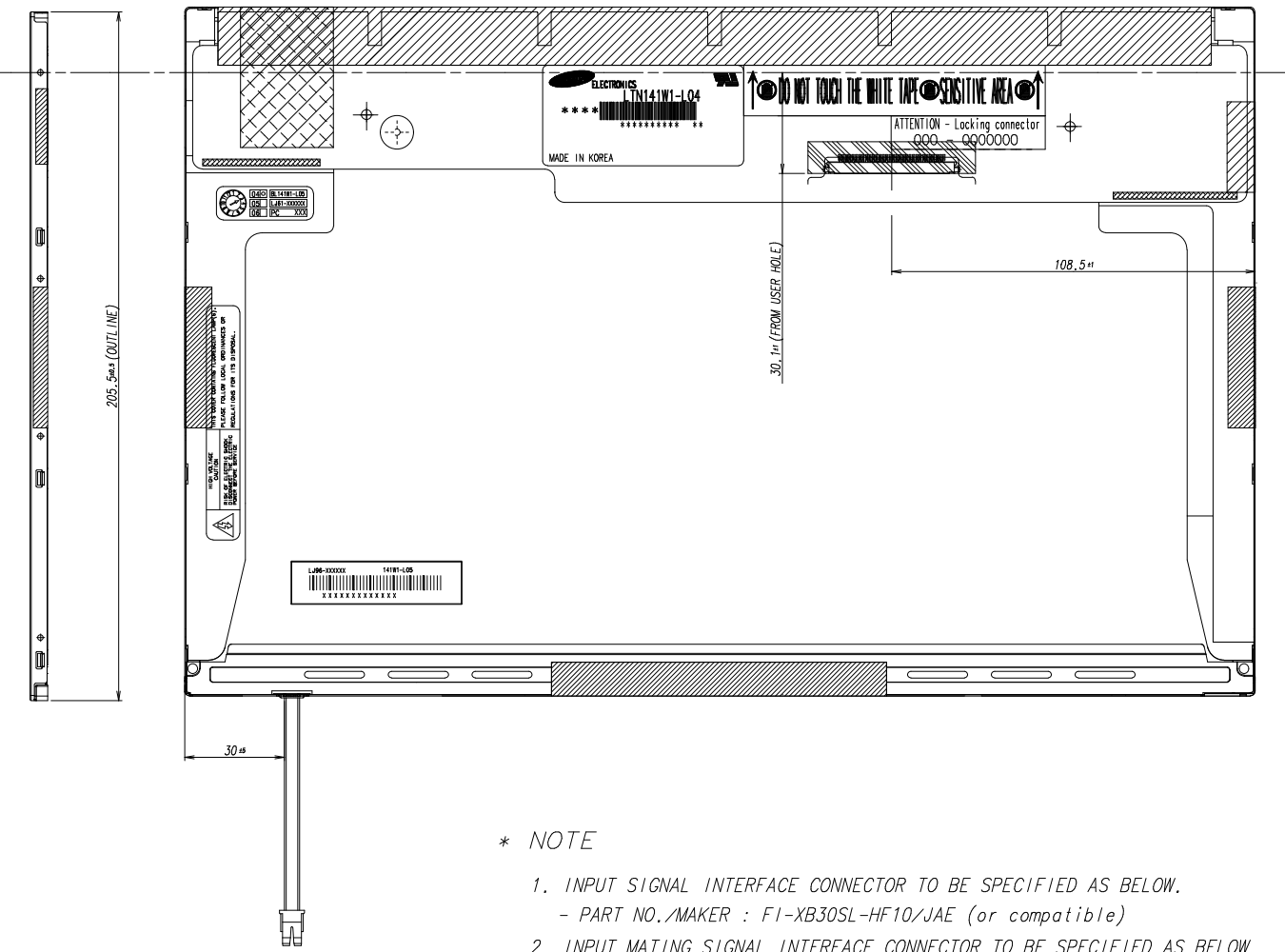

* NOTE

- INPUT SIGNAL INTERFACE CONNECTOR TO BE SPECIFIED AS BELOW.
- PART NO./MAKER : FI-XB30SL-HF10/JAE (or compatible)
- INPUT MATING SIGNAL INTERFACE CONNECTOR TO BE SPECIFIED AS BELOW.
- PART NO./MAKER : FI-X30M/JAE (or compatible)
- CCFT CONNECTOR FOR BACKLIGHT TO BE SPECIFIED AS BELOW.
- PART NO./MAKER : BHSR-02VS-1/JST (or compatible)
- CALIFERS MEASURING FORCE : 530 ± 150 gf
- USER HOLE TORQUE SPEC : 3.0Kgfcm MAX (5 TIMES)
- WEIGHT SPEC : 405g MAX

REVISED

GENERAL TOLERANCE				REV	DATE	DESCRIPTION OF REVISION				REASON		CHG'D BY	
STEP	LEVEL 1	LEVEL 2	LEVEL 3	UNIT	mm	DRA'N BY	DES'D BY	CHK'D BY	APP'D BY	MODEL NAME	LTN141W1-L04		
0 < X ≤ 4	±0.05	±0.1	±0.2	SCALE	1/1	Y.K.NIM		Y.J.LEE	D.C.YANG	PART/SHEET NAME	Outline-Dimension	SHEET 1/1	
4 < X ≤ 16	±0.08	±0.15	±0.3	TOLERANCE			05.07.04		05.07.04	SPEC. NO.			
16 < X ≤ 64	±0.12	±0.25	±0.5	SAMSUNG ELECTRONICS									VER. 000
64 < X ≤ 256	±0.25	±0.4	±0.8										